



UPS

400VA-2000VA

USER MANUAL



Line Interactive UPS

1 Important Safety Information

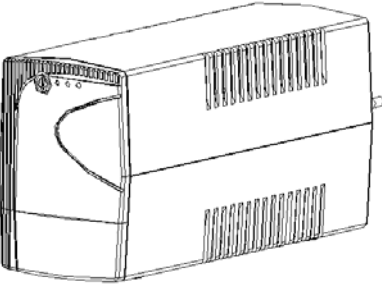
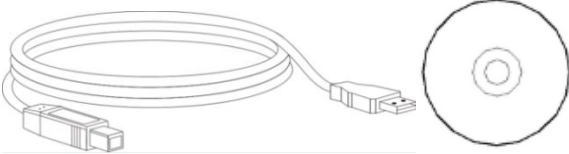

- This UPS is intended for indoor use only.
- Do not install the UPS in direct sunlight, in excessive heat, humidity or dust, or in contact with fluids.
- Be sure the air vents on the UPS are not blocked. Allow adequate space for proper ventilation.
- Do not connect non-computer-related equipment, such as medical equipment, life-support equipment, microwave ovens, and vacuum cleaners to UPS.
- Do not plug the UPS power cord into its own power outlet.
- In the event of an emergency, press the OFF button and disconnect the power cord from the AC input power.
- Connect the UPS power cable directly to AC outlet. Do not use surge protectors or extension cords.
- If the UPS is with metal chassis, it must be grounded when installing UPS to reduce leakage current to less than 3.5 mA.
- Unplug the UPS prior to cleaning and do not use liquid or spray detergent.
- Servicing of batteries should be performed by qualified personnel. When replace batteries the UPS must be OFF, and its AC inlet is unplugged.
- Replace batteries with the same number and type of batteries as originally installed in the equipment. (Internal battery is sealed, lead-acid, 6-cell battery and the battery voltage is 12 Vdc).
- Do not dispose of batteries in a fire. The batteries may explode.
- Do not open or mutilate batteries. They contain an electrolyte that is toxic and harmful to the skin and eyes.
- To avoid harmful injury due to energy hazard, the following precautions must be observed before replacing the batteries:
 - Remove watches, rings, or other metal objects.
 - Use tools with insulated handles.
 - Wear rubber gloves and boots.
 - Do not lay tools or metal parts on the top of batteries.
 - Disconnect charging source prior to connecting or disconnecting battery terminals.

2 Inventory

 <p>UPS unit (reference picture)</p>	 <p>Communication cable, CD (only for the model with USB/RS232 port)</p>	 <p>UPS 400VA-2000VA USER MANUAL Line Interactive UPS User manual</p>
---	--	--

3 Product Overview

LED front panel features

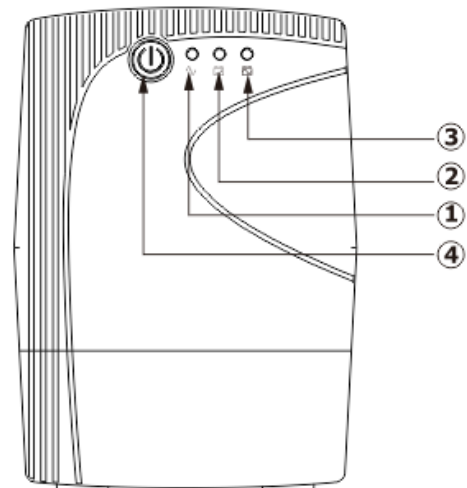
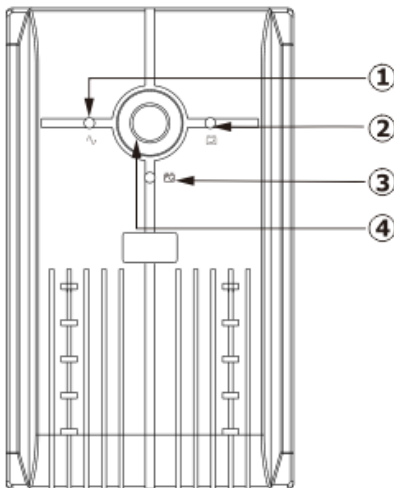

- ① Green indicator light -- indicates AC output. It illuminates continuously when the utility power is on.
- ② Yellow indicator light -- indicates battery status. It flashes when it is charging and illuminates continuously when it is fully charged.
- ③ Red indicator light -- indicates DC output. It illuminates continuously when the UPS is in inverter mode.
- ④ Power On/Off button

LCD front panel features

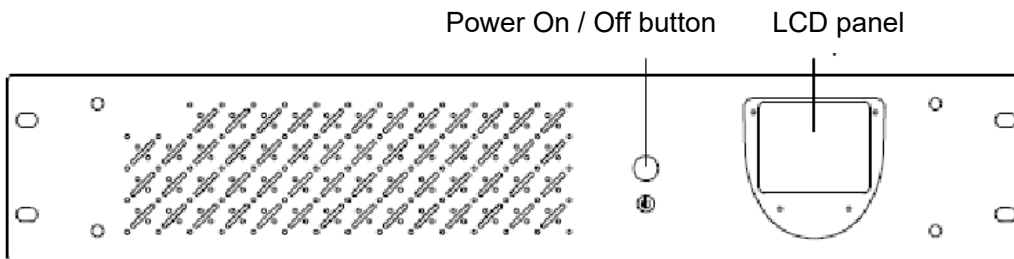
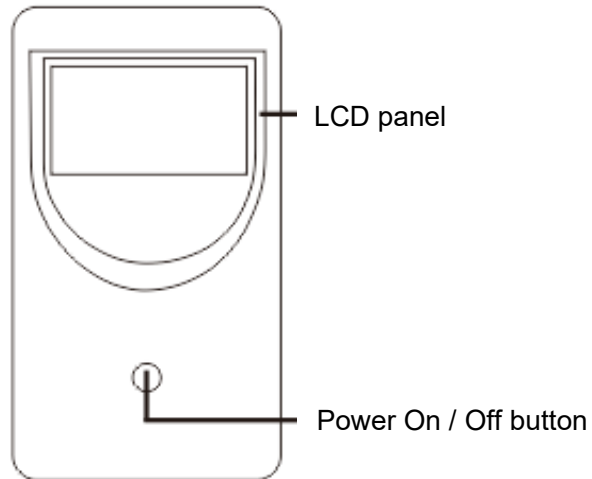

- ① Alarm
- ② Hello
- ③ Battery capacity
- ④ Load capacity
- ⑤ Output voltage
- ⑥ Input voltage/frequency

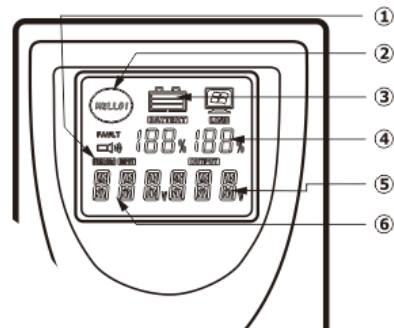

- ① AC mode
- ② Battery mode
- ③ Output voltage
- ④ Load
- ⑤ Battery

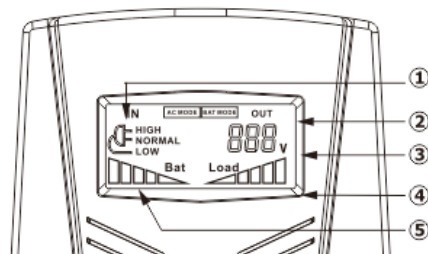

Rear panel features

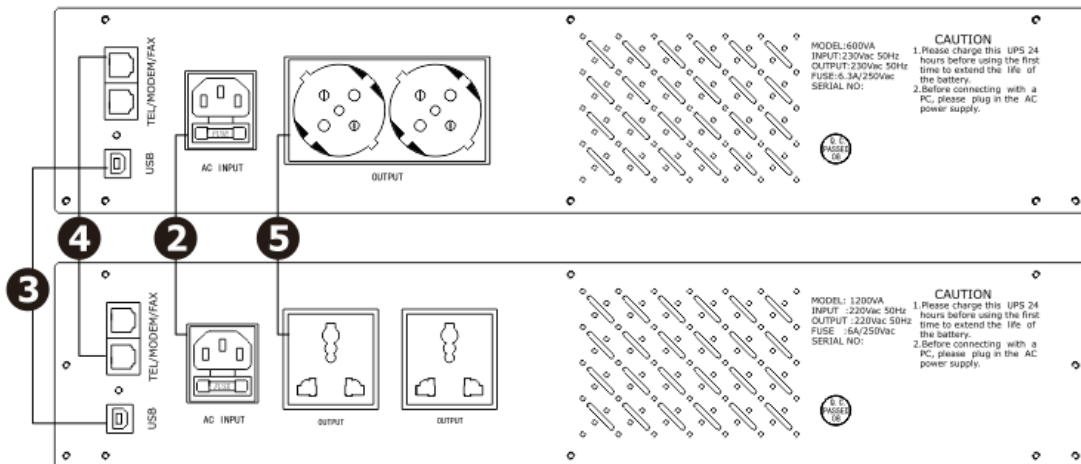
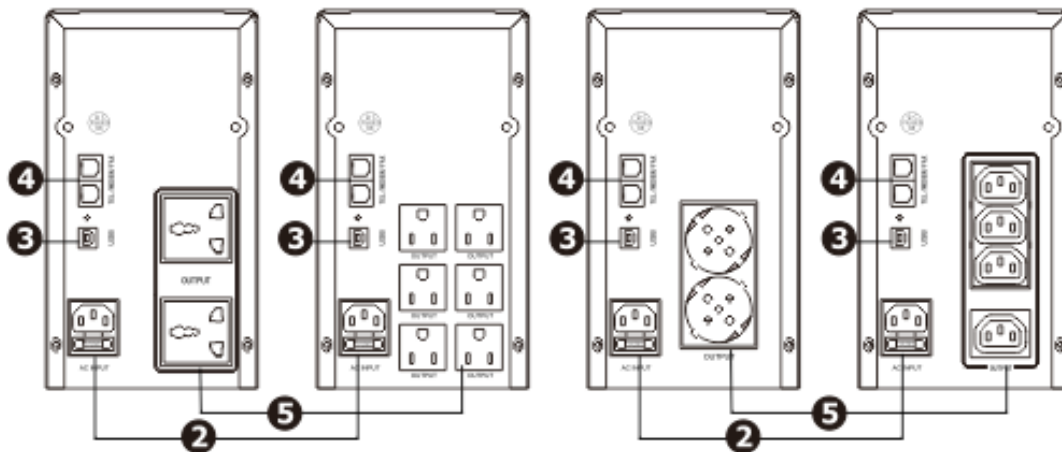
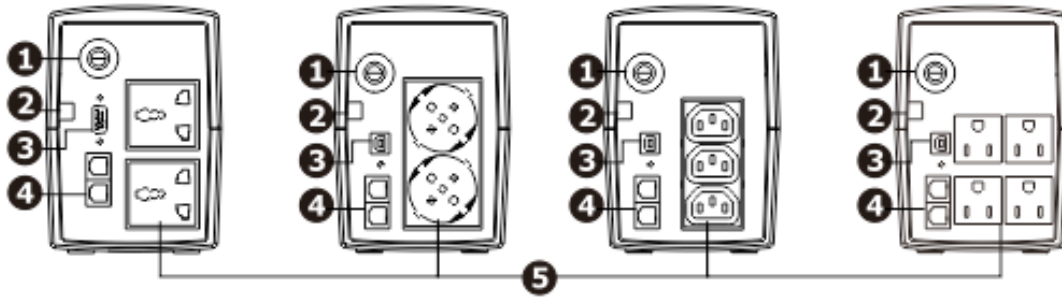

- ❶ AC fuse
- ❷ AC input
- ❸ RS232 / USB communication port (optional)
- ❹ RJ11 / RJ45 (optional)
- ❺ Output outlets

4 Installation & Initial Startup

Note: Inspect unit before installation. Ensure that nothing inside the package is damaged.

Location & storage conditions

Install the UPS in a protected area that is free of excessive dust and with sufficient ventilation. Please place the UPS away from other units at least 20 cm to avoid interference. DO NOT operate the UPS in places where the temperature and humidity exceed the specific limits. (Please check the specifications for the limitations)



Connect to utility power and charging

Plug the AC power cord into the wall outlet. It is suggested to charge the battery for at least 8 hours before initial use. The unit charges its battery while connecting to utility power.



Connect to the load

Connect equipment to the outlets on the rear panel of the UPS. Connect the UPS to the utility power. When the UPS is receiving input power, the battery backup with surge protection outlets will supply power to connected equipment. During a power outage or other utility problems, the battery backup outlets receive power for a limited time from the UPS.

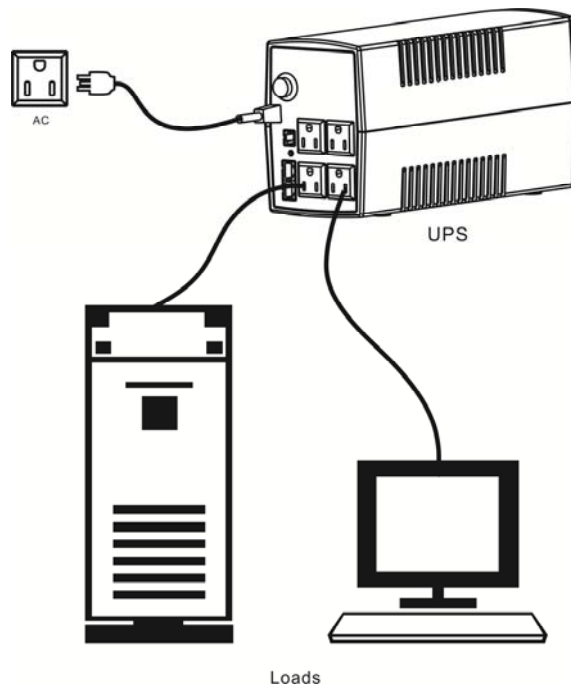

	CAUTION
	NEVER connect a laser printer or a scanner to the UPS unit. This may cause damage to the unit.



Connect TEL/Modem/Fax for surge protection (Only for the model with RJ11 / RJ45)

Connect a single model/phone line to surge-protected “IN” outlet on the rear panel of the UPS. Connect “OUT” outlet to the computer with another phone line.

Connect communication cable (Only for the model with USB / RS232 port)

Allow for unattended UPS shut down/ start-up and status monitoring, connect one end of the communication cable to UPS / RS232 port and the other end to the communication port of PC. With the monitoring software installed, you can schedule UPS shutdown/start-up and monitor UPS status via PC.

Turn on / off the UPS

- Press the power On/Off button to turn on the LED UPS unit. Press the power On/Off button again to turn off the LED UPS unit.
- Press the power On/Off button for 3 seconds to turn on the LCD UPS unit. Press the power On/Off button again for 3 seconds to turn off the LCD UPS unit.

Cold start function

When the UPS is off and utility power is unavailable, it is still possible to cold start the UPS unit to power the loads.

Alarm function

- When utility power fails, the UPS is running on battery, it emits an audible alarm once every 6 seconds and the alarm stops in about 40 seconds
- When the battery is about to run out, the UPS will emit an audible alarm once every 2 seconds.
- When the battery runs out of power, the UPS will emit an audible alarm for a long time and shut down automatically.

Protections

- Battery overdischarge protection: When the battery discharges and the UPS is in inverter mode, the UPS will execute a self test of the battery working status. When the battery voltage drops to the limited lowest voltage, the UPS will shut down automatically to protect the battery. When utility power is restored, the UPS will restart automatically.
- Battery overcharge protection: The UPS charges the internal battery when it is in AC mode. Its battery-testing system will automatically detect the battery charge status. When the battery is fully charged, the charging system will close automatically to ensure the service life of the battery and energy conservation.
- Short circuit protection: When the UPS is in battery mode with electric shock or short-circuit, and UPS will shut down automatically. (When the UPS is in AC mode, the UPS will be protected by input fuse firstly and then transfers to the battery mode.)

Lock phase

In AC mode, the UPS automatically tracks AC phase and ensures that the output waveform of the inverter is synchronous with AC voltage waveform, which can reduce the peak pulse and surge voltage and minimize the interference and damage to the device.

Detective input frequency

When it is connected to utility power, the frequency is automatically set to 50Hz or 60Hz in accordance with the utility power.

5 Software Download & Installation

(Only for the model with communication port)

Please follow steps below to install the software and monitor the UPS:

- Insert CD disc into computer, select installation icon and follow the on-screen instructions to install the software.
- Connect the UPS and computer with communication cable.
- Open the software, select proper port to monitor the UPS.

6 Maintenance

Preventative maintenance

Performing the following activities periodically keeps the UPS in good working order and helps to prevent failures:

- Be sure the air vents on the UPS are not blocked.
- Be sure the UPS surface is not covered by dust.
- Be sure the input, output and battery cables are securely connected.
- Be sure the UPS is not affected with damp.
- Make the UPS operate on battery for several minutes and check if it works normally or not.

Battery maintenance

The batteries in the UPS are Sealed Lead Acid (SLA) batteries. The battery typically lasts for two to five years. Environmental factors impact battery life. Elevated ambient temperatures, poor quality utility power and frequent short duration discharges will shorten battery life. Batteries require recharging every three months after extended outages. If the battery is near the end of its service life, consider replacing the battery.

7 Troubleshooting

Use the table below to solve minor problems.

Problem	Possible cause	Solution
The utility power is available and the plug is fully inserted into the mains outlet, but the UPS is operating on battery power.	Fuse has been tripped.	The fuse is located on the rear panel of the UPS. Disconnect the UPS from utility power. Replace the fuse with a new one.
There is no output during a utility power outage.	Battery voltage is too low	Turn on the UPS when utility power is available and charge the battery for at least 10 hours.
The UPS does not provide the expected amount of backup time.	The UPS is overloaded.	Disconnect non-essential equipment.
	Battery voltage is too low.	Charge the battery for at least 10 hours.
	The battery has reached the end of its useful life.	Replace the battery.

8 Specifications

MODEL	400 VA 450 VA	600 VA 650 VA	800 VA 850 VA	1000 VA	1200 VA	1500 VA 1600 VA	2000 VA 2200 VA	
Capacity	240 W	360 W	480 W	600 W	720 W	900 W	1200 W	
INPUT								
Voltage	100 V / 110 V / 120 V: 80 ~ 150 Vac or 220 V / 230 V / 240 V: 162 ~ 295 Vac (220V: 145 ~ 295 Vac optional)							
Frequency	50 / 60 Hz ± 10% (auto-sense)							
OUTPUT								
Voltage	100 V / 110 V / 120 Vac ± 10% or 220 V / 230 V / 240 Vac ± 10%							
Frequency	50 / 60 Hz ± 1% (auto-sense)							
Waveform	Mains mode: pure sine wave; Battery mode: simulated sine wave							
Transfer time	2 ~ 7 ms (typical), 10 ms (max.)							
BATTERIES								
DC voltage	12 V			24 V				
Configuration	12 V / 4.5 Ah × 1	12 V / 7 Ah × 1	12 V / 8 Ah × 1	12 V / 7 Ah × 2	12 V / 8 Ah × 2	12 V / 9 Ah × 2		
Recharge time	6 ~ 8 h							
COMMUNICATIONS								
USB / RS232 / SNMP (optional)	Support Windows® 98 / 2000 / 2003 / XP / Vista / 2008 / Windows® 7 / 8 / 10							
OTHERS								
Protections	Short circuit – battery overcharge – overdischarge – overload – surge							
Humidity	20 ~ 90% RH @ 0 ~ 40°C (non-condensing)							
Noise	≤ 45 dB (1m)							
Plastic case	Net / Gross weight (kg)	3.7 / 4.0	4.3 / 4.6	5.2 / 5.5	8.6 / 9.0	10.1 / 10.5	—	
	Dimensions (W×D×H) (mm)	100×290×140			140×345×170			—
	Packaged dimensions (W×D×H) (mm)	139×335×210			198×406×245			—
	Quantities / 20ft	2300 pcs			1000 pcs			—
Metal case	Net / Gross weight (kg)	—	5.1 / 5.4	6.3 / 6.6	9.6 / 10.1	11.3 / 11.7	12.9 / 13.3	
	Dimensions (W×D×H) (mm)	—	95×320×160		125×320×225		125×380×225	
	Packaged dimensions (W×D×H) (mm)	—	145×375×230		180×390×295		180×450×295	
	Quantities / 20ft	—	2000 pcs		1000 pcs			
Rack mount	Net / Gross weight (kg)	—	7.0 / 7.5	8.2 / 8.7	11.6 / 12.1	13.3 / 13.8	14.9 / 15.4	
	Dimensions (W×D×H) (mm)	—	308×438×88		308×438×132			
	Packaged dimensions (W×D×H) (mm)	—	395×525×185		395×525×225			