

# **Outdoor Parking Space Detector**

## **User's Manual**



# Foreword

## General





This manual introduces the installation, functions and operations of the outdoor parking space detector (hereinafter referred to as "the Camera"). Read carefully before using the Camera, and keep the manual safe for future reference.

## Models

Models	Lens
ITC439-PW1H-LZ	Short range
ITC439-PW1H-LZF1050	Long range

## Safety Instructions

The following signal words might appear in the manual.

Signal Words	Meaning
 <b>DANGER</b>	Indicates a high potential hazard which, if not avoided, will result in death or serious injury.
 <b>WARNING</b>	Indicates a medium or low potential hazard which, if not avoided, could result in slight or moderate injury.
 <b>CAUTION</b>	Indicates a potential risk which, if not avoided, could result in property damage, data loss, reductions in performance, or unpredictable results.
 <b>TIPS</b>	Provides methods to help you solve a problem or save time.
 <b>NOTE</b>	Provides additional information as a supplement to the text.

## Revision History

Version	Revision Content	Release Time
V1.0.0	First release.	January 2022

## Privacy Protection Notice

As the Camera user or data controller, you might collect the personal data of others such as their face, fingerprints, and license plate number. You need to be in compliance with your local privacy protection laws and regulations to protect the legitimate rights and interests of other people by implementing measures which include but are not limited: Providing clear and visible identification to inform people of the existence of the surveillance area and provide required contact information.

## About the Manual

- The manual is for reference only. Slight differences might be found between the manual and the product.
- We are not liable for losses incurred due to operating the product in ways that are not in compliance with the manual.

- The manual will be updated according to the latest laws and regulations of related jurisdictions. For detailed information, see the paper user's manual, use our CD-ROM, scan the QR code or visit our official website. The manual is for reference only. Slight differences might be found between the electronic version and the paper version.
- All designs and software are subject to change without prior written notice. Product updates might result in some differences appearing between the actual product and the manual. Please contact customer service for the latest program and supplementary documentation.
- There might be errors in the print or deviations in the description of the functions, operations and technical data. If there is any doubt or dispute, we reserve the right of final explanation.
- Upgrade the reader software or try other mainstream reader software if the manual (in PDF format) cannot be opened.
- All trademarks, registered trademarks and company names in the manual are properties of their respective owners.
- Please visit our website, contact the supplier or customer service if any problems occur while using the Camera.
- If there is any uncertainty or controversy, we reserve the right of final explanation.

# Important Safeguards and Warnings

This section introduces content covering the proper handling of the Camera, hazard prevention, and prevention of property damage. Read carefully before using the Camera, and comply with the guidelines when using it.

## Transportation Requirements



Transport the Camera under allowed humidity and temperature conditions.

## Storage Requirements



Store the Camera under allowed humidity and temperature conditions.

## Installation Requirements



- Do not connect the power adapter to the Camera while the adapter is powered on.
- Strictly comply with the local electrical safety code and standards. Make sure the ambient voltage is stable and meets the power supply requirements of the Camera.
- Do not connect the Camera to two or more kinds of power supplies, to avoid damage to the Camera.



- Personnel working at heights must take all necessary measures to ensure personal safety including wearing a helmet and safety belts.
- Do not place the Camera in a place exposed to sunlight or near heat sources.
- Keep the Camera away from dampness, dust, and soot.
- Put the Camera in a well-ventilated place, and do not block its ventilation.
- Use an adapter or cabinet power supply provided by the manufacturer.
- The power supply must conform to the requirements of ES1 in IEC 62368-1 standard and be no higher than PS2. Please note that the power supply requirements are subject to the Camera label.
- The device is a class I electrical appliance. Make sure that the power supply of the Camera is connected to a power socket with protective earthing.
- An emergency disconnect device must be installed during installation and wiring at a readily accessible location for emergency power cut-off.
- Disconnect the Camera when installing and connecting the lens.

## Operation Requirements



- Make sure that the power supply is correct before use.
- Do not unplug the power cord on the side of the Camera while the adapter is powered on.
- Operate the Camera within the rated range of power input and output.
- Use the Camera under allowed humidity and temperature conditions.

- Do not drop or splash liquid onto the Camera, and make sure that there is no object filled with liquid on the Camera to prevent liquid from flowing into it.
- Do not disassemble the Camera.
- Do not aim the Camera at strong light sources (such as lamplight, and sunlight) when focusing it.
- Do not vibrate, squeeze or immerse the Camera in liquid during transportation, storage or installation.
- Do not block the ventilation near the Camera.
- We recommend you use the Camera with a lightning protection device for stronger protection against lightning. For outdoor scenarios, strictly comply with the lightning protection regulations.
- Ground the function earthing portion of the Camera (grounding cable or lightning surge protector) to improve its reliability. The device is a class I electrical appliance. Make sure that the power supply of the Camera is connected to a power socket with protective earthing.
- The device must be used with the protective cover for outdoor scenarios to avoid the risk of water damage to the Camera.
- Protect the line cord and wires from being walked on or squeezed particularly at plugs, power sockets, and the point where they exit from the Camera.
- Modify the default password of the Camera after first-time login to prevent the Camera from being stolen.

## Maintenance Requirements

- Pack the Camera with packaging provided by its manufacturer or packaging of the same quality before sending it back for repair.
- Please do not touch the photosensitive device with your hands. Use an air blower to clean off the dust and filth on the lens.
- Clean the surface of the Camera with a soft dry cloth or a clean soft cloth dipped in neutral detergent.
- Use the accessories suggested by the manufacturer. Installation and maintenance must be performed by qualified professionals.

# Table of Contents

Foreword .....	I
Important Safeguards and Warnings.....	III
<b>1 Introduction .....</b>	<b>1</b>
<b>1.1 Overview .....</b>	<b>1</b>
<b>1.2 Features.....</b>	<b>1</b>
<b>2 Structure .....</b>	<b>2</b>
<b>2.1 Appearance.....</b>	<b>2</b>
<b>2.2 Dimensions .....</b>	<b>2</b>
<b>2.3 Structure .....</b>	<b>2</b>
<b>2.4 Cables .....</b>	<b>3</b>
<b>3 Installation.....</b>	<b>5</b>
<b>3.1 Installation Requirements.....</b>	<b>5</b>
<b>3.2 Installing the Camera.....</b>	<b>6</b>
<b>4 Camera Configurations .....</b>	<b>8</b>
<b>4.1 Initialization .....</b>	<b>8</b>
<b>4.2 Changing IP Address.....</b>	<b>8</b>
<b>5 Web Configuration .....</b>	<b>10</b>
<b>5.1 Web Login.....</b>	<b>10</b>
<b>5.1.1 Recommended Configuration.....</b>	<b>10</b>
<b>5.1.2 Login .....</b>	<b>10</b>
<b>5.1.3 Resetting Password .....</b>	<b>11</b>
<b>5.1.4 Web Functions.....</b>	<b>12</b>
<b>5.2 Live.....</b>	<b>13</b>
<b>5.2.1 Video Stream.....</b>	<b>13</b>
<b>5.2.2 Live View .....</b>	<b>13</b>
<b>5.2.3 Functions of the Live Page .....</b>	<b>14</b>
<b>5.2.4 Live View Snapshot.....</b>	<b>16</b>
<b>5.2.5 Event List.....</b>	<b>16</b>
<b>5.3 Query .....</b>	<b>16</b>
<b>5.3.1 Image Search.....</b>	<b>16</b>
<b>5.3.1.1 SD Picture .....</b>	<b>16</b>
<b>5.3.1.2 Image Downloading Attribute .....</b>	<b>17</b>
<b>5.3.1.3 PC Picture.....</b>	<b>18</b>
<b>5.3.2 Recording Search.....</b>	<b>18</b>
<b>5.3.2.1 Recording.....</b>	<b>18</b>

<b>5.3.2.2 Watermark</b> .....	19
<b>5.3.3 Parking Record Search</b> .....	20
<b>5.4 Setting</b> .....	20
<b>5.4.1 ITC</b> .....	20
<b>5.4.1.1 Parking Space Configuration</b> .....	20
<b>5.4.1.1.1 Detecting Parking Space</b> .....	21
<b>5.4.1.1.2 Counting Available Spaces</b> .....	21
<b>5.4.1.2 Illegal Parking Area</b> .....	23
<b>5.4.1.3 OSD Configuration</b> .....	24
<b>5.4.1.3.1 Video OSD</b> .....	24
<b>5.4.1.3.2 Snapshot OSD</b> .....	24
<b>5.4.2 Camera</b> .....	26
<b>5.4.2.1 Camera Attribute</b> .....	26
<b>5.4.2.1.1 General</b> .....	26
<b>5.4.2.1.2 Advanced Attributes</b> .....	28
<b>5.4.2.1.3 Metering Zone</b> .....	28
<b>5.4.2.2 Video</b> .....	29
<b>5.4.2.2.1 Video</b> .....	29
<b>5.4.2.2.2 Snapshot</b> .....	30
<b>5.4.2.2.3 Region of Interest</b> .....	31
<b>5.4.3 Network</b> .....	32
<b>5.4.3.1 TCP/IP</b> .....	32
<b>5.4.3.2 Port</b> .....	33
<b>5.4.3.3 Auto Register</b> .....	34
<b>5.4.3.4 Platform</b> .....	34
<b>5.4.3.4.1 ONVIF</b> .....	34
<b>5.4.3.4.2 Info Push Platform</b> .....	35
<b>5.4.4 Event</b> .....	35
<b>5.4.4.1 Alarm</b> .....	36
<b>5.4.4.1.1 Relay Activation</b> .....	36
<b>5.4.4.1.2 Relay-out</b> .....	37
<b>5.4.4.2 Abnormality</b> .....	37
<b>5.4.5 Storage</b> .....	38
<b>5.4.5.1 Point</b> .....	38
<b>5.4.5.2 Local</b> .....	38
<b>5.4.5.3 Save Path</b> .....	39
<b>5.4.6 System</b> .....	39
<b>5.4.6.1 General</b> .....	39

<b>5.4.6.1.1 General Setup</b> .....	39
<b>5.4.6.1.2 Date &amp; Time</b> .....	40
<b>5.4.6.2 Account</b> .....	40
<b>5.4.6.2.1 User Account</b> .....	40
<b>5.4.6.2.2 ONVIF User</b> .....	42
<b>5.4.6.3 Safety</b> .....	42
<b>5.4.6.3.1 System Service</b> .....	42
<b>5.4.6.3.2 HTTPS</b> .....	43
<b>5.4.6.3.3 Firewall</b> .....	47
<b>5.4.6.4 Default Settings</b> .....	47
<b>5.4.6.5 Import/Export</b> .....	47
<b>5.4.6.6 Automatic Maintenance</b> .....	48
<b>5.4.6.7 Update</b> .....	48
<b>5.4.7 Information</b> .....	48
<b>5.4.7.1 Version</b> .....	48
<b>5.4.7.2 Log</b> .....	49
<b>5.4.7.2.1 System Log</b> .....	49
<b>5.4.7.2.2 Remote log</b> .....	50
<b>5.4.7.3 Online User</b> .....	50
<b>5.4.7.4 Legal Information</b> .....	50
<b>5.5 Alarm</b> .....	50
<b>5.6 Logout</b> .....	50
<b>Appendix 1 Cybersecurity Recommendations</b> .....	51

# 1 Introduction

## 1.1 Overview

The Camera detects the status of outdoor parking spaces in real time, providing guidance for drivers. It applies to highway service areas, large outdoor parking lots, large industrial parks and high-speed train stations.

## 1.2 Features

- Detects the status of parking spaces and counts available parking spaces.
- The installation height can be 6 m–25 m for standard environments. It also monitors multiple parking spaces.
- Motorized vari-focal lens.
- Displays the number of both occupied and available parking spaces.
- The Camera supports two methods for counting available parking spaces, meeting the requirements of various customers.
- You can configure the type of parking spaces, simplifying the management of available parking spaces in parking areas for both large and small vehicles.

# 2 Structure

## 2.1 Appearance

Figure 2-1 ITC439-PW1H-Z



Figure 2-2 ITC439-PW1H-Z1050



## 2.2 Dimensions

Figure 2-3 ITC439-PW1H-Z (mm [inch])

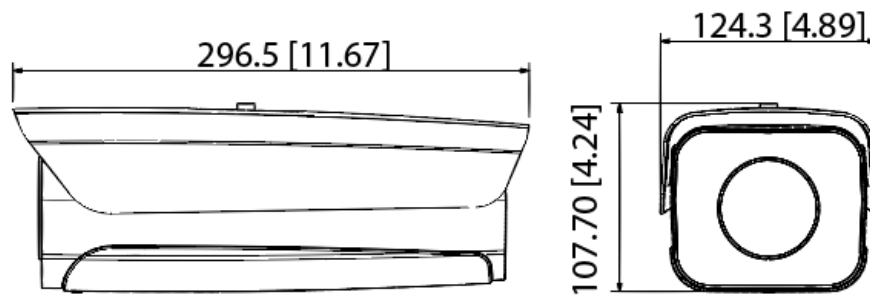
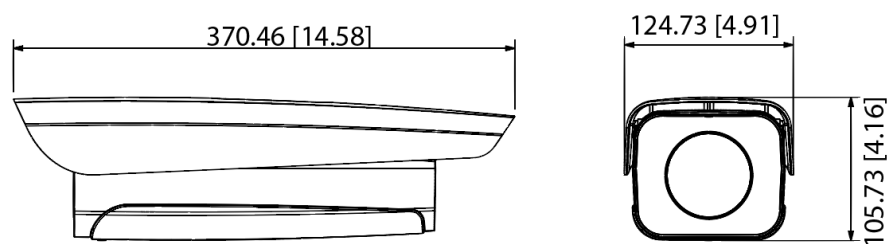

Figure 2-4 ITC439-PW1H-Z1050 (mm [inch])



## 2.3 Structure

Figure 2-5 Structure

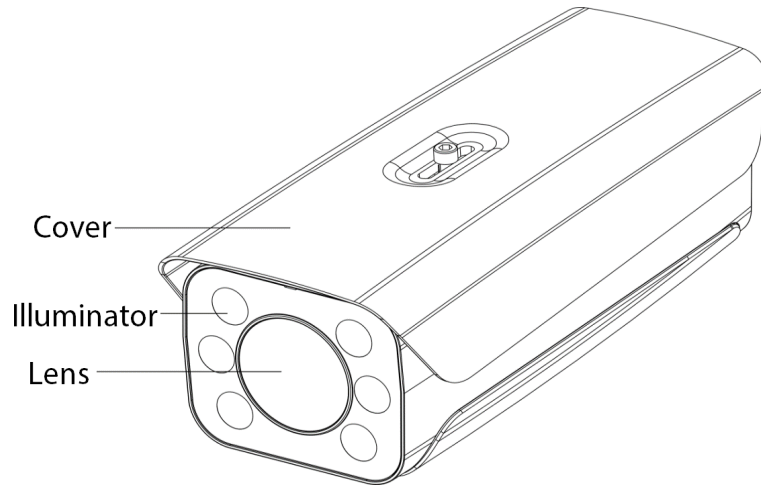
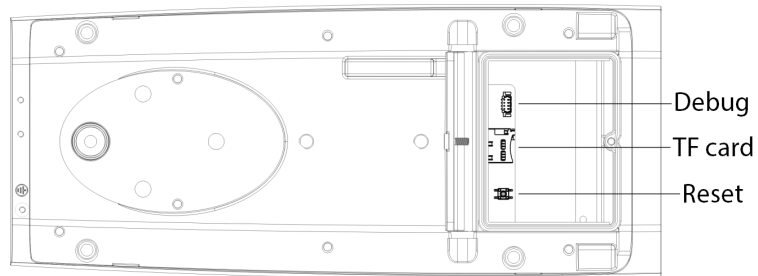

Figure 2-6 Rear panel



## 2.4 Cables

Figure 2-7 External cables

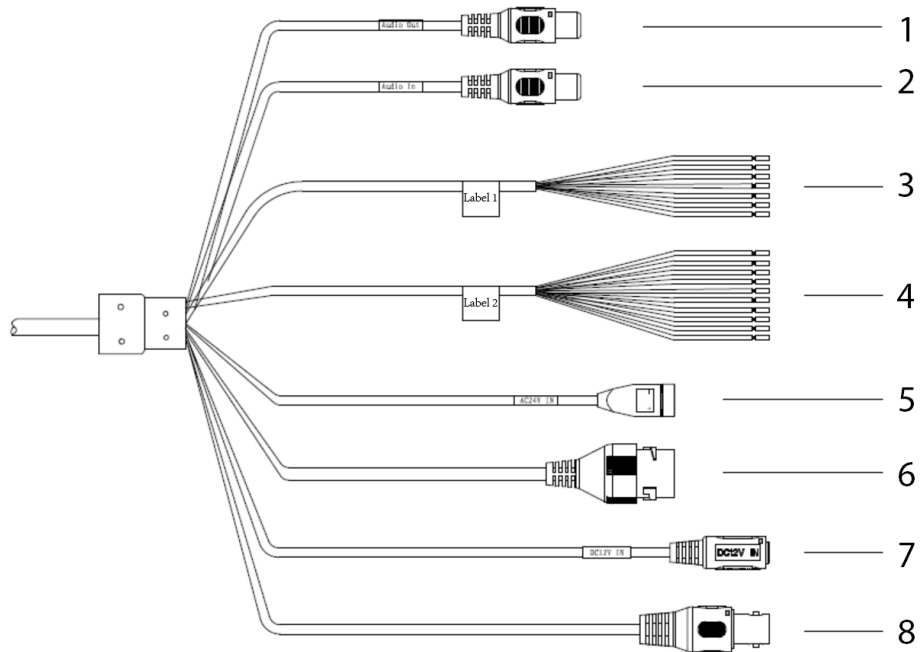



Table 2-1 Description of external cables

No.	Port	Description
1	AUDIO OUT	Outputs audio
2	AUDIO IN	Inputs audio

No.	Port	Description
3	RS-485/RS-232	<ul style="list-style-type: none"> <li>● White and red: RS-485_A1</li> <li>● White and orange: RS-485_B1</li> <li>● Yellow and gray: RS-485_A2</li> <li>● Yellow and black: RS-485_B2</li> <li>● White and yellow: RS-232_RXD</li> <li>● White and brown: RS-232_TXD</li> <li>● White and black: GND</li> </ul>
4	ALARM	<p>Gray: ALARM_IN_GND</p> <ul style="list-style-type: none"> <li>● Alarm output <ul style="list-style-type: none"> <li>◇ Brown: ALARM_NO1</li> <li>◇ Green: ALARM_COM1</li> <li>◇ White and pink: ALARM_NO2</li> <li>◇ Light green: ALARM_COM2</li> <li>◇ Red: ALARM_NO3</li> <li>◇ Black: ALARM_COM3</li> </ul> </li> <li>● Alarm input <ul style="list-style-type: none"> <li>◇ Blue: ALARM_IN1</li> <li>◇ White: ALARM_IN2</li> <li>◇ Yellow: ALARM_IN3</li> </ul> </li> </ul>
5	24 VAC	<p>Inputs 24 VAC power supply. Make sure to supply power to the Camera under the instructions on the label.</p>  <p>The Camera might be damaged if the power supply is incorrect.</p>
6	LAN	<p>Connects to standard Ethernet cables for power supply. PoE is available.</p>
7	12 VDC	<p>Inputs 12 VDC power supply. Make sure to supply power to the Camera under the instructions on the label.</p>  <p>The Camera might be damaged if the power supply is incorrect.</p>
8	BNC	<p>Connects to panorama cameras.</p>

# 3 Installation



The following installation figures are for reference only, and might differ from the actual product.

## 3.1 Installation Requirements

For perpendicular parking and diagonal parking, the installation positions of the Camera are different.

Figure 3-1 Perpendicular parking

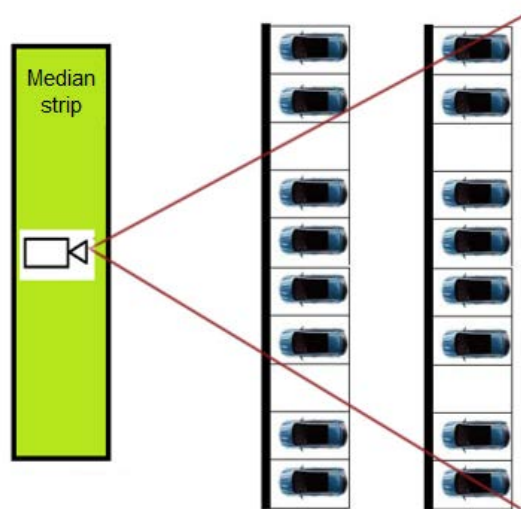
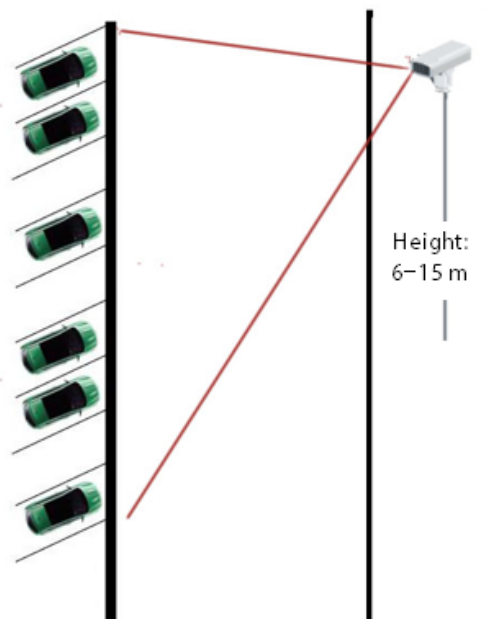

Figure 3-2 Diagonal parking



- The Camera must face the head of the vehicle.
- The installation height can be 6 m–30 m.
- Make sure that vehicles do not block each other.

- Targets blocked by trees might not be recognized. When the vehicle to be recognized is blocked by other vehicles, make sure the blockage is less than 40%.
- For small vehicle spaces, install the Camera perpendicular to the space. For large vehicle spaces, install the Camera facing the vehicle head.

Figure 3-3 Large vehicle space

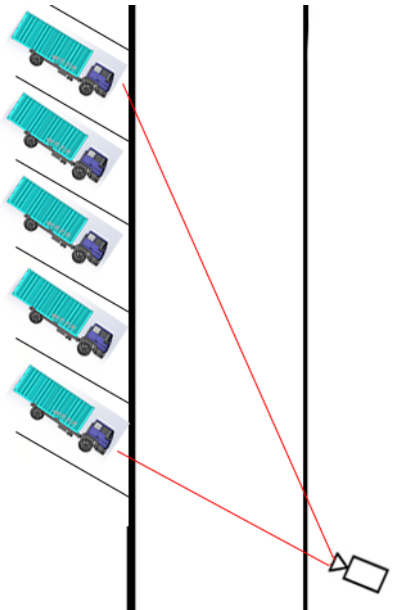

- A vehicle can be recognized only when its width is no less than 80 pixels in the video image.
- The number of vehicles that can be monitored depends on the installation height and the horizontal distance between the Camera and the parking space.

## 3.2 Installing the Camera

The Camera can be installed with a universal bracket, on a wall or a pole.



This section uses the installation method with universal bracket as an example.

Figure 3-4 Universal bracket

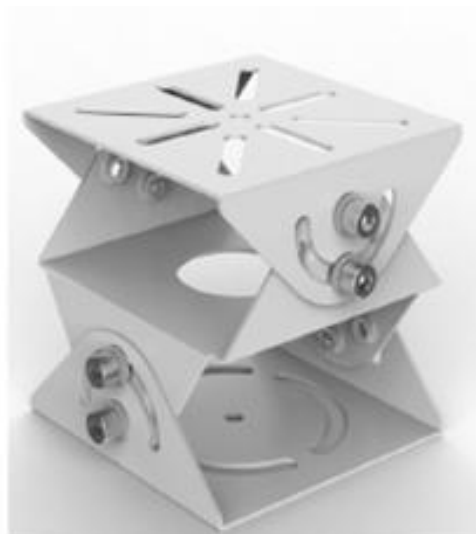

Figure 3-5 Wall mount bracket



Figure 3-6 Pole mount bracket



Step 1 Use M6 × 14 screws to fix the universal joint on the bracket.

Step 2 Use two 1/4-20 × 14UNC screws to fix the camera on the universal bracket.

Figure 3-7 Universal bracket installation

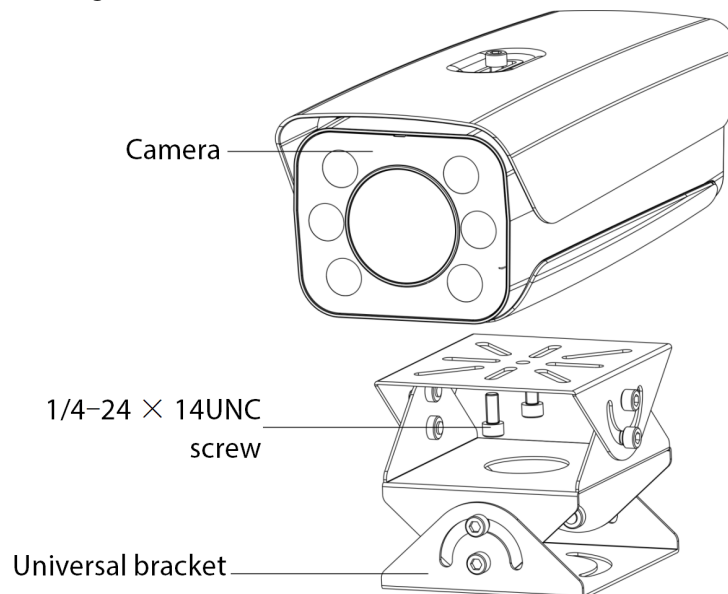

Step 3 Adjust the angle of the universal bracket and the Camera.

# 4 Camera Configurations

## 4.1 Initialization

### Prerequisites

- The Camera is delivered uninitialized by default. You need to initialize it and change its password before further operations.
- Before initialization, make sure both IP of the computer and the Camera are on the same network segment, otherwise the initialization might fail.

### Procedure

Step 1 Set IP address, subnet mask, and gateway of the computer and the Camera respectively.



The IP address of the Camera is 192.168.1.108 by default.

Step 2 Open browser, enter the IP address of the Camera in the address bar, and then press the Enter key.

Figure 4-1 Device initialization

Device Initialization

Username: admin

Password:

The minimum pass phrase length is 8 characters

Weak Middle Strong

Confirm Password:

Use a password that has 8 to 32 characters, it can be a combination of letter(s), number(s) and symbol(s) with at least two kinds of them.(please do not use special symbols like \"; : & )

Email Address:

To reset password, please input properly or update in time.

Confirm

Step 3 Enter and confirm the new password.

Step 4 Select **Email Address**, and then enter your email address for resetting your password.

Step 5 Click **Confirm**.

## 4.2 Changing IP Address

You can acquire and change IP addresses of devices accessed through wired network. This section uses changing IP address with ConfigTool as the example.

Step 1 Start ConfigTool, and then click **Modify IP** on the homepage.

Step 2 Select the device(s) whose IP need(s) to be changed.

- Change one IP address: Click **Edit** corresponding to the device.
- Change IP addresses in batches: Select the devices, and then click **Batch Modify IP**.

Step 3 Set mode, IP, subnet mask and gateway.

Step 4 Click **OK**.

Figure 4-2 Change IP addresses in batches

Modify IP Address

Mode  Static  DHCP

Target IP

Subnet Mask

Gateway

OK

Selected number of devices: 1

# 5 Web Configuration

Log in to the web client of the Camera through browser on the computer, and then you can modify basic configurations, perform business operations and management.



The pages and settings are for reference only, and might differ from the actual page.

## 5.1 Web Login

### 5.1.1 Recommended Configuration

Table 5-1 Recommended PC configuration

PC Component	Recommended Configuration
Operating System	Windows 7, and later
CPU	Intel core i3, and faster processor
Graphics	Intel HD Graphics, and later
RAM	2 GB, and larger
Monitor	1024 × 768, and higher
Browser	Internet Explorer 9/11, Chrome 33/41, Firefox 49

### 5.1.2 Login

**Step 1** You can log in to the web page by following the steps below. For first-time login or login after restoring factory default settings, see "4.1 Initialization".

**Step 2** Enter the IP address of the Camera in the browser address bar, and then press Enter.

**Step 3** Enter your login username, and password, and then click **Login**.



- A box pops up when the username or password is incorrect.
- If you enter invalid user name or password for five times, the account will be locked for five minutes.

Figure 5-1 Invalid username or password

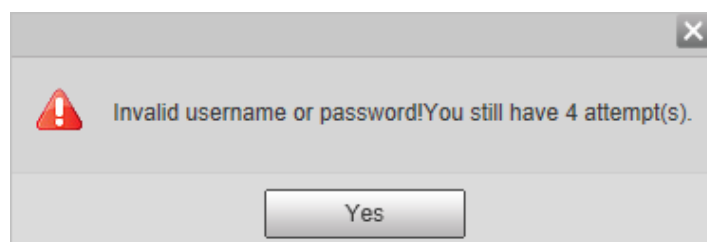

## 5.1.3 Resetting Password

When you forgot your password, you can configure new password through the password reset function.



- Email address must be filled in during device initialization; otherwise it will fail to send you the security code, and you will not be able to reset your password. Email address of admin can be modified from **Setting > System > Account > Account**.
- The Camera can be reset up to 10 times in one day.
- When scanning QR code to acquire security code, one QR code can get two security codes at most.
- After receiving security code by email, you need to reset password within 24 hours, otherwise, the security code will be invalid.

**Step 1** Open the browser, enter the IP address of the Camera in the browser address bar, and then press Enter.

**Step 2** Click **Forgot password?**

**Step 3** Click **OK** in the prompted window.

**Step 4** Scan the QR code according to the page prompt, and send the scanning result to designated email, and acquire security code.



Scan the actual QR code. Do not scan the QR code in this manual.

Figure 5-2 Reset password (1)

Reset the password(1/2)

QR code:

Note(For admin only):  
Please use an APP to scan the left QR code to get special strings. And then send the strings to support\_gpwd@hmicrochip.com.

The security code will be delivered to 1\*\*\*@gmail.com.

Security code:

Cancel Next

**Step 5** Enter received security code in the text box of **Security code**.

**Step 6** Click **Next**.

Figure 5-3 Reset password (2)

**Step 7** Enter and confirm the new password.

**Step 8** Click **OK**.

### 5.1.4 Web Functions

This section mainly introduces the following 6 functions on the web client.

Figure 5-4 Tab



Table 5-2 Tab function description

Tab	Function
Live	View and record live video, adjust video and image window, set image parameter, and more.
Query	Search for different types of pictures and videos, and configure watermark verification of them.
Setting	Set rules of intelligent traffic, camera basic attribute, network, event, storage, and system, and view system information.
Alarm	Set alarm prompt.
Logout	Log out of the web client.

The following buttons are very common on the web page.

Table 5-3 Common buttons description

Button	Description
	Restore all parameters to system defaults.
	Recover the parameters to the value last saved.
	Save the settings.

## 5.2 Live

Click the **Live** tab.

On this page, several functions such as live video, live picture, real-time capture, record, and config (LPR), and more are supported.

Figure 5-5 Live

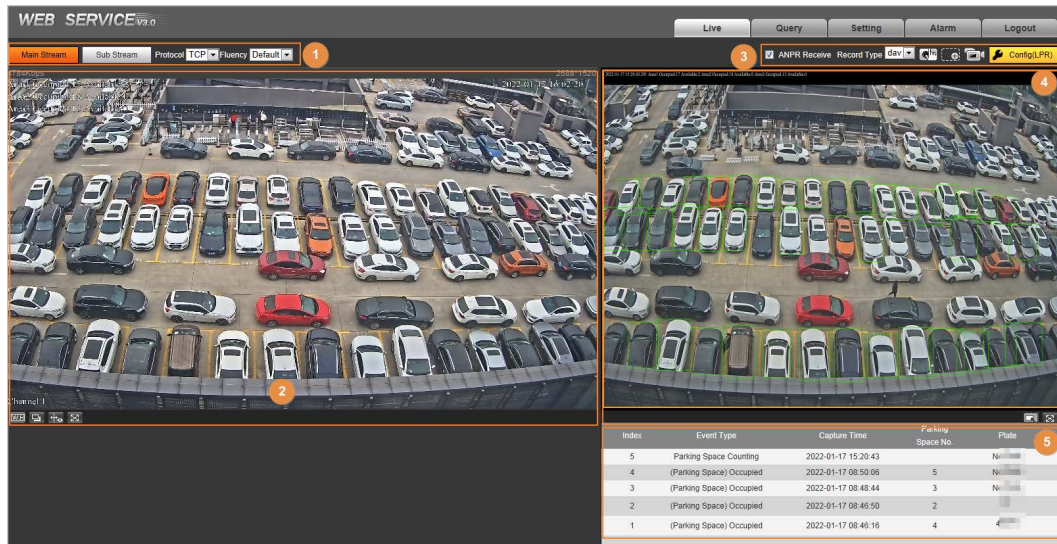

Table 5-4 Live page description

No.	Description
1	Video stream type, protocol and fluency
2	Live view
3	Functions of <b>Live</b> page
4	Live view snapshot
5	Event list

### 5.2.1 Video Stream

- **Main Stream:** Make sure that the Camera can record video, and carry out network surveillance when the network is normal. You can configure main stream resolution within the supported range of the Camera.
- **Sub Stream:** Replaces main stream to make network surveillance, and reduces the network bandwidth possession when network bandwidth is insufficient.
- **Protocol:** Video surveillance protocol, currently it only supports TCP.
- **Fluency:** Fluency of viewing the live video. The fluency can be set to **High**, **Middle**, **Low**, and **Default** (recommended).

### 5.2.2 Live View

Displays the live video captured by the Camera. You can also click the icons to change the display mode of live view.

- : Adjust the image to original size or adapt to the window.



- : Click it to switch to big window, and click  on the lower-left corner to display image adjustment window. Click it again to exit big window.

Figure 5-6 Big window







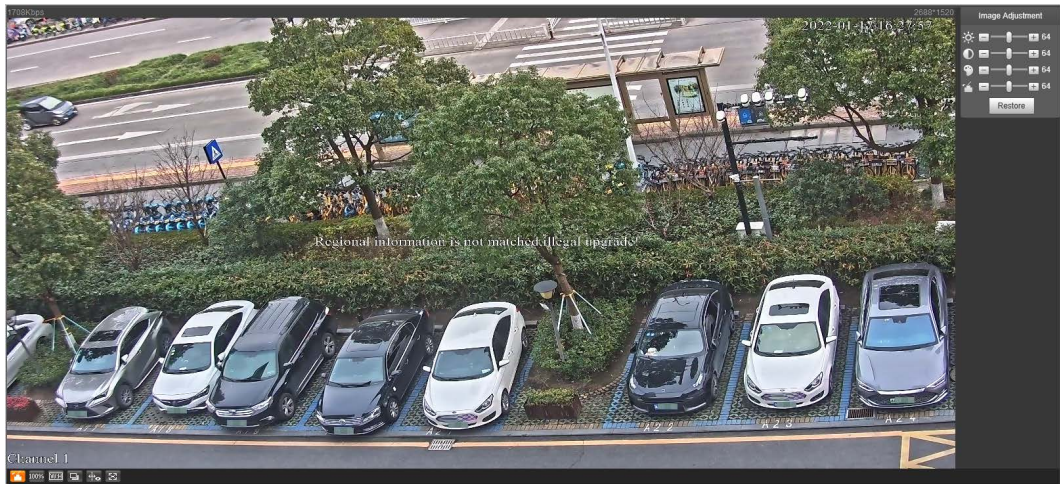



- : Click it to display the original image of the Camera.
- : Click it to enable smart track detection. Number plate, vehicle bounding box, and other smart tracking information will be displayed in the video image.
- : Click it, and the window is displayed in full screen; double-click or right-click to exit full screen.

Table 5-5 Image adjustment description

Icon	Name	Description
	Brightness	Adjust the overall image brightness. Change the value when the image is too bright or too dark. The range is from 0 to 128 (64 by default).
	Contrast	Change the value when the image brightness is proper but contrast is not enough. The range is from 0 to 128 (64 by default).
	Hue	Adjust the image hue. For example, change red into blue. The default value is made by the light sensor, and normally it does not have to be adjusted. The range is from 0 to 128 (64 by default).
	Saturation	Adjust the color vividness, and will not influence the image overall brightness. The range is from 0 to 128 (64 by default).
	—	Restore brightness, contrast, saturation, and hue to default values.



In this image adjustment window, you can only adjust image brightness, contrast, hue, and saturation of local web. To adjust system brightness, contrast, hue, and saturation, go to **Setting > Camera > Camera Attribute > General**.

### 5.2.3 Functions of the Live Page

This section introduces operations such as image, and video capture, zoom, record, and talk.

Figure 5-7 General function option column

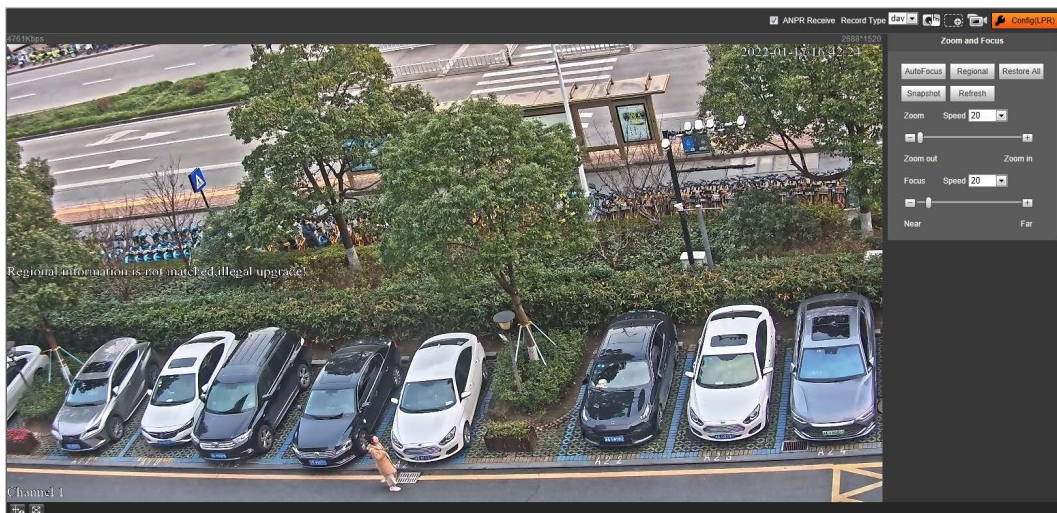

Table 5-6 General function description

Icons	Name	Description
	ANPR Receive	Select the checkbox, and the Camera automatically receives vehicle snapshots, and detects event information triggered by sources such as radar or video detection, and displays such snapshots, and information at the lower part of the page. The snapshots are saved in the storage path defined by <b>Setting &gt; Storage &gt; Destination &gt; Save Path</b> .
	Record Type	Select the format of video recordings ( <b>dav</b> by default).
	Manual Snapshot	Take a snapshot when a vehicle passes. The snapshot is saved in the storage path.  <ul style="list-style-type: none"> <li>• Enable <b>ANPR Receive</b> first.</li> <li>• To change the storage path of snapshots, go to <b>Setting &gt; Storage &gt; Destination &gt; Save Path</b>.</li> </ul>
	Digital Zoom	Drag to select any area in the video window, and then the area will be zoomed in. In any area of the video window, click  or right-click to exit.
	Video Recording	Click it to start recording. Click  to stop recording. You can set the storage path of video recordings from <b>Setting &gt; Storage &gt; Destination &gt; Save Path</b> .
	Config (LPR)	You can adjust the zoom and focus of the Camera.

Step 1 Click .





Figure 5-8 Config (LPR)



Step 2 Set the focus and zoom mode.

Table 5-7 Focus parameter description

Parameter	Description
Auto Focus	Automatically adjust the camera lens to make the scenario clearly focused.

Parameter	Description
Regional	Click <b>Regional</b> , and then draw a rectangle in the video image to focus the marked region.
Restore All	Restore all to initialized settings.
Snapshot	Click it to stop the image to check the adjusted effect of zoom and focus.
Manual Focus	<ul style="list-style-type: none"> <li>• <b>Zoom:</b> <ul style="list-style-type: none"> <li>◇ Speed: Select the adjustment speed of the Camera zoom .</li> <li>◇ Zoom in, zoom out: Click  to zoom in, click  to zoom out; or directly drag the adjustment bar to set zoom.</li> </ul> </li> <li>• <b>Focus:</b> <ul style="list-style-type: none"> <li>◇ Speed: Select the adjustment speed of the Camera focus .</li> <li>◇ Near, far: Click  to focus on far place, click  to focus on near place. You can also directly drag the adjustment bar to set the focal length.</li> </ul> </li> </ul>

## 5.2.4 Live View Snapshot

When marked parking spaces are occupied or available parking spaces changed in the configured area, the Camera takes a snapshot and records an event. You can also manually take a snapshot.

## 5.2.5 Event List

Select **ANPR Receive**, and the event information will be displayed, including index, event type, capture time, parking space number and the corresponding plate.



When the Camera is set to count available parking spaces, plate numbers are not recognized.

## 5.3 Query

Click the **Query** tab, and the system displays query page where you can search for pictures, and video recordings.

### 5.3.1 Image Search

#### 5.3.1.1 SD Picture

Search conditions can be set in this section. You can search for pictures on the SD card within the period.

Step 1 Select **Query > Image Search > SD Card Image**.

Step 2 Set the capture begin time, end time and event type and then click **Search**.

Figure 5-9 SD picture

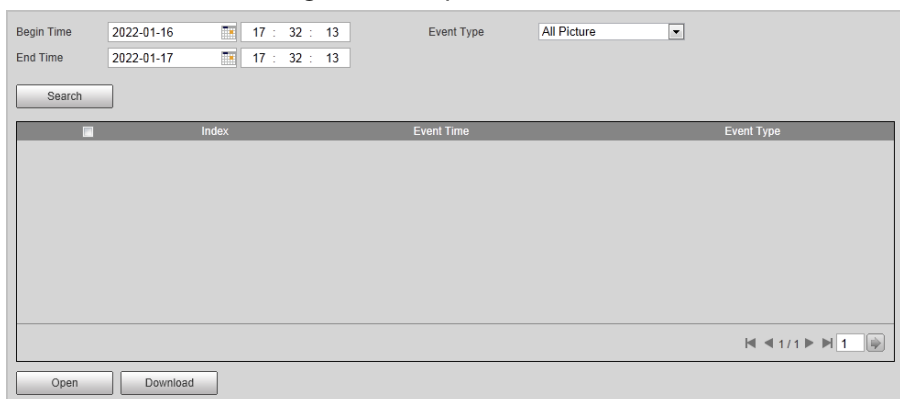

- Step 3 Select a picture, click **Open** to see the picture details.
- Step 4 Select pictures, and then click **Download** to download pictures to local computer.

### 5.3.1.2 Image Downloading Attribute

In this section, you can set the picture download time and naming rules.

- Step 1 Select **Query > Image Search > Downloading Attribute**.
- Step 2 Configure the download parameters.

Figure 5-10 Download attribute

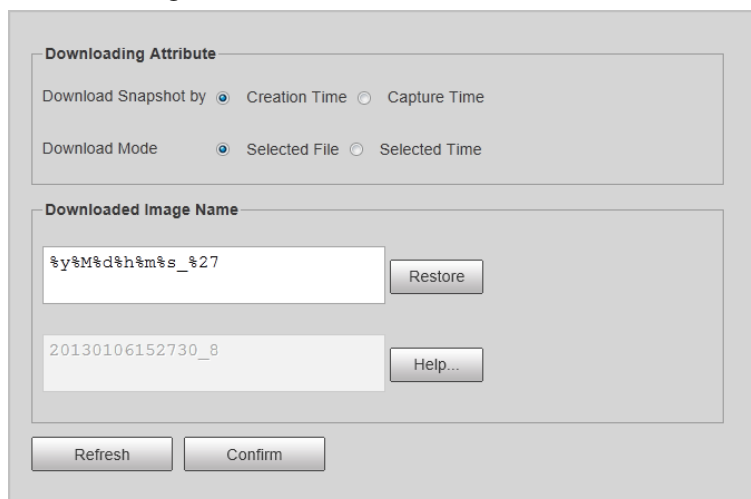

Table 5-8 Download attribute description

Parameter	Description
Download Snapshot by	<ul style="list-style-type: none"> <li>• <b>Creation Time:</b> When you download snapshot on PC, the downloading time in image attribute is snapshot storage time.</li> <li>• <b>Capture Time:</b> When you download snapshot on PC, the downloading time in image attribute is snapshot capture time.</li> </ul>
Download Mode	<ul style="list-style-type: none"> <li>• <b>Selected File:</b> Select the needed picture (It supports selecting single picture or several pictures at the same time), click <b>Download</b>, and the system will pop out the save dialog box.</li> <li>• <b>Selected Time:</b> Click <b>Download</b>, and the system will automatically download all the pictures within the defined time.</li> </ul>
Restore	Restore the picture name to default.
Help...	View the naming rule of downloaded pictures.

Step 3 Click **Confirm**.

### 5.3.1.3 PC Picture

With watermark verification, the Camera can check whether the captured snapshot is tampered. If the snapshot is verified with watermarks, the authenticity of the snapshot is guaranteed.

Step 1 Select **Query > Image Search > PC Picture**.

Step 2 Click **Browse**, and select the folder where the picture to be verified is located.

Figure 5-11 PC picture

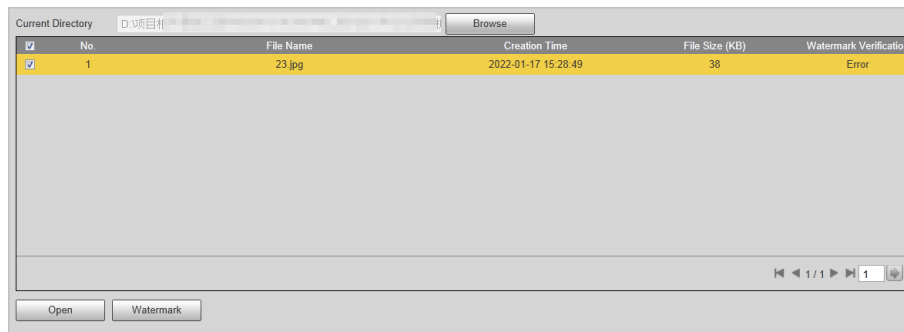

Step 3 Select the picture which needs to be verified.

Step 4 Click **Watermark**, and view result under **Watermark Verification**.

- When the result is **Error**, the picture is tampered.
- When the result is **Normal**, the picture is not tampered.



Click **Open** or double-click the picture if you need to preview the picture.

## 5.3.2 Recording Search

The Camera allows you to play local recordings, add watermarks to them and verify whether the video is tampered by using watermarks.

### 5.3.2.1 Recording

Step 1 Select **Query > Recording Search > Recording**.

Step 2 Click **Browse**, select a recording from your local storage, and then click **Open**.

Functions, such as adjust image size, IVS and full screen are supported while you play the recording.

Figure 5-12 Play the recording

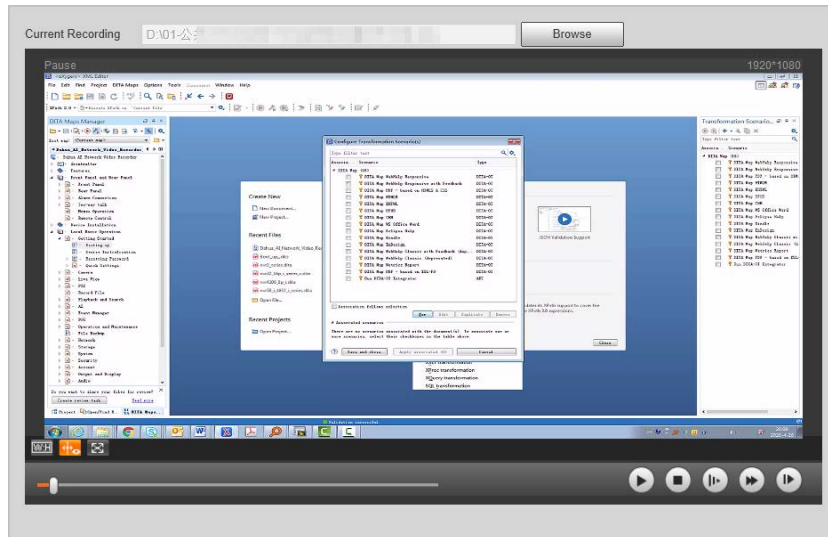





Table 5-9 Play function description

Icon	Description
	Stop playing.
	Slow down.
	Speed up.
	Play the next frame.

### 5.3.2.2 Watermark

By verifying watermarks, you can check whether the local video recorded by the Camera is tampered.



Video watermark can be set on the web client from **Setting > Camera > Video > Video**.

**Step 1** Select **Query > Recording Search > Water Mark**.

**Step 2** Click **Browse**, and select a recording that you want to verify.

**Step 3** Click **Watermark**, and the Camera displays verification progress.

- If the video is verified to be authentic, the watermark you set is displayed next to **Normal Watermark**.
- If the video is tampered, you can check the details next to **Tampered Watermark**.

Figure 5-13 Watermark

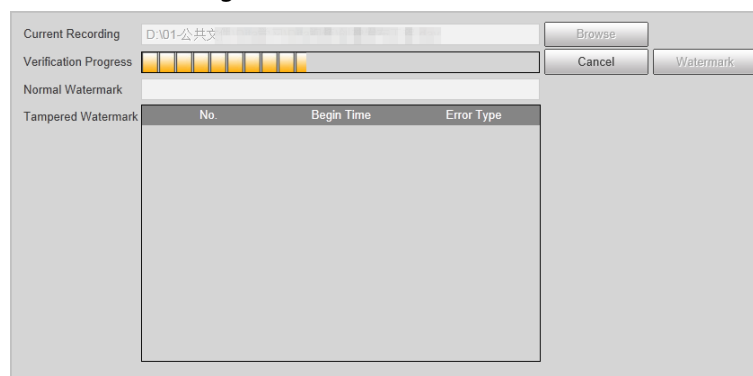

## 5.3.3 Parking Record Search

Search for the vehicle parking record within the defined period.



It supports max 10,000 records or 1,024 records respectively when the Camera is installed with or without TF card.

**Step 1** Select **Query > Parking Record > Parking Record**.

**Step 2** Set the search conditions, event type and plate number.

- **Parking Space No.:** Select parking spaces to view the corresponding records.



When the Camera is set to count available spaces, select **1** only to view the corresponding records.

- **Event Type:** The status of the selected parking spaces during the set period.
- **Plate Number:** Enter plate number to search for records of the specified vehicle only.

**Step 3** Click **Search**.

Figure 5-14 Parking record search

Index	Event Time	Channel	Parking Space No.	Event Type	Plate	Attribute	Subscribed IP
1	2022-01-14 17:14:53	1	1	(Parking Space) Occupied	None	None	172.24.3.59;10.34.98.82;17.2.24.0.53
2	2022-01-14 17:14:53	1	2	(Parking Space) Occupied	D7	None	172.24.3.59;10.34.98.82;17.2.24.0.53
3	2022-01-14 17:14:53	1	3	(Parking Space) Occupied	None	None	172.24.3.59;10.34.98.82;17.2.24.0.53
4	2022-01-14 17:14:53	1	4	(Parking Space) Occupied	None	None	172.24.3.59;10.34.98.82;17.2.24.0.53
5	2022-01-14 18:14:47	1	4	(Parking Space) Available	None	None	172.24.3.59;10.34.98.82;17.2.24.0.53;171.5.26.91

**Step 4** (Optional) Click **Export by Time** or **Export All** to export parking records of the defined period or all records to local computer.

## 5.4 Setting

You can configure several parameters such as parking space detection mode, camera attributes, network, event, storage, system, and system information.

### 5.4.1 ITC

You can set the parking space detection mode of the Camera.

#### 5.4.1.1 Parking Space Configuration

The Camera can detect whether the parking space is occupied, count available spaces in an area, and monitor events such as vehicles parking over the set detection lines.

### 5.4.1.1.1 Detecting Parking Space

Set a parking zone and parking spaces inside the zone to allow the Camera to detect whether the specified parking space is occupied and recognize the vehicle.

#### Procedure

- Step 1** Select **Setting > ITC > Park Space Config > Parking Space Management**.
- Step 2** Under **Intelligence**, set **Mode** to **Parking Space Detection**.  
For **Detection Threshold**, we recommend you leave it as default.
- Step 3** Under **Parking Space Management**, enter the **Parking Zone** name, and then click **Add Parking Space** to add parking spaces for the Camera to monitor.
- The type and number must be filled in for each parking area.
  - The Camera can monitor 4 parking spaces at most.
- Step 4** Click **Add Detection Line**, and draw lines between the parking spaces. The Camera detects when vehicle are parking over the line and triggers alarms based on the drawn lines.

Figure 5-15 Parking space management

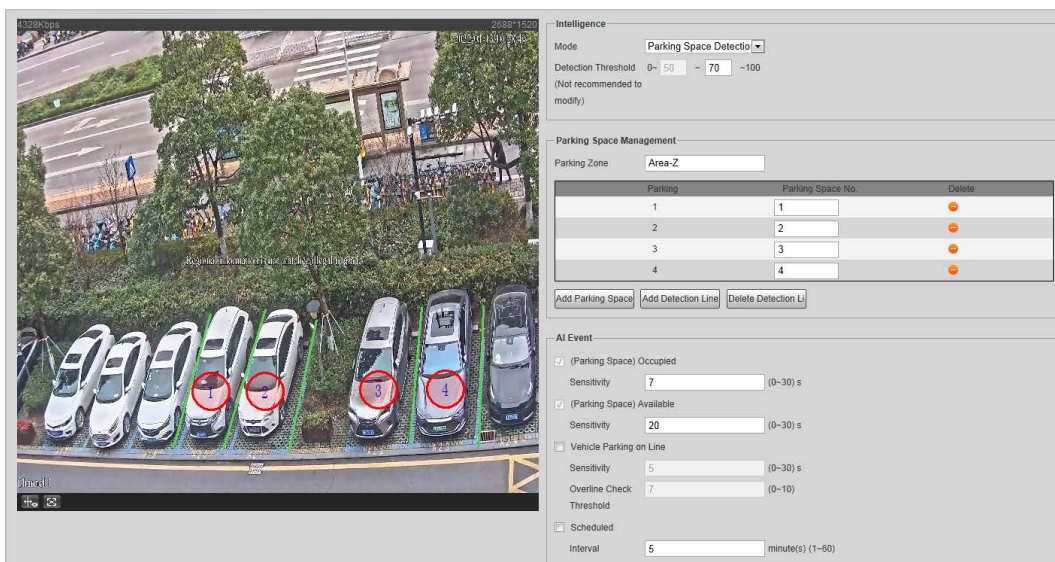

- Step 5** Under **AI Event**, select AI events as needed and then set the corresponding sensitivity.
- **(Parking Space) Occupied** and **(Parking Space) Available** are selected by default under this mode. You can change the sensitivity of both events.
  - **Vehicle Parking on Line** is detecting whether the vehicle has parked on the drawn detection lines.
  - **Scheduled Internal** event takes a snapshot at the set interval, you can roughly deduce the time point when a parking space status changes based on the snapshots.
- Step 6** Click **Confirm**.

#### Related Operations

- Click  to delete a parking space.
- Click **Delete Detection Line** to delete a drawn detection line.

### 5.4.1.1.2 Counting Available Spaces

Set a parking zone and divide parking areas inside the zone, so the Camera can monitor parking spaces in each area and output available spaces in real time.

## Procedure

- Step 1** Select **Setting > ITC > Park Space Config > Parking Space Management**.
- Step 2** Under **Intelligence**, set **Mode** to **Available Space Count**.  
Select **Vehicle Box**, each vehicle will be marked with a frame to make it easy to distinguish them.
- Step 3** Set **Confidence Level** to filter out false detections.
- Step 4** Set **Counting Mode**.



The Camera supports monitoring up to 50 parking spaces.

- **Parking Space:** Count available spaces based on the configured individual parking spaces.



We recommend you leave **Custom Algorithm** as default.

1. Click each parking space on the video image. With each click, a green circle (available) or red circle (occupied) is displayed.
2. On the left side, set the parking space number and type.

Figure 5-16 Parking space management

The screenshot displays the 'Parking Space Management' interface. On the left is a video feed of a parking lot with several cars. Red circles are overlaid on some cars, indicating they are occupied. On the right is the configuration panel. The 'Intelligence' section includes: Mode (Available Space Count), Vehicle Box (checked), Confidence Level (60), Counting Mode (Parking Space), and Custom Algorithm (match strategy=1). The 'Parking Space Management' section includes: Parking Zone (Area-Z), a Clear button, and a table of parking spaces.

Parking	Parking Space No	Parking Space Type	Delete
1	C01	Small Vehicle	✖
2	C02	Small Vehicle	✖
3	C03	Small Vehicle	✖
4	C04	Small Vehicle	✖
5	C05	Small Vehicle	✖
6	C06	Small Vehicle	✖
7	C07	Small Vehicle	✖
8	C08	Small Vehicle	✖

Buttons: Default, Refresh, Confirm

- **Area:** Count available spaces based on the configured parking area.
  1. Click on the video image, draw a parking area according to the actual site, and then right-click to finish.
  2. On the left side, set the parking region name, the number of vehicles that the region contains and type.

Figure 5-17 Parking space management

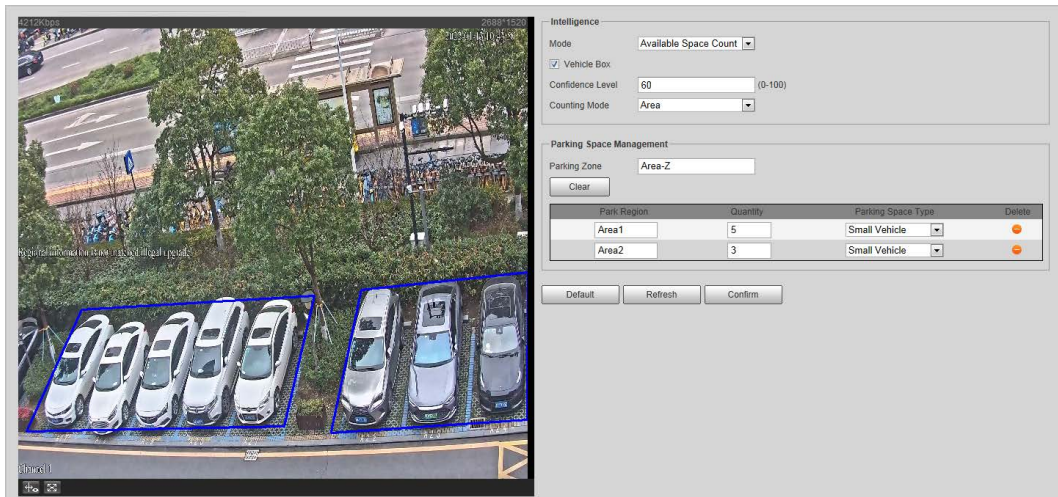

**Step 5** Click **Confirm**.

## Related Operations

Click  to delete a parking space or area.

### 5.4.1.2 Illegal Parking Area

You can set areas where no parking is allowed, and the Camera triggers an alarm when a vehicle parks inside the set areas for a period longer than the **Allowed Parking Time**.

**Step 1** Select **Setting > ITC > Park Space Config > Illegal Parking Area**.

**Step 2** Select **On** to enable illegal parking monitoring.

**Step 3** Set **Allowed Parking Time**. When the time period a vehicle parks inside the illegal area exceeds the set threshold, the Camera will trigger an alarm.

**Step 4** Click **Illegal Parking**, and then click on the video image to draw an area.

- Change the region name as needed.
- Click on the drawn area to change its shape, size and position.
- The Camera supports monitoring 2 illegal parking areas at most.

Figure 5-18 Illegal parking area

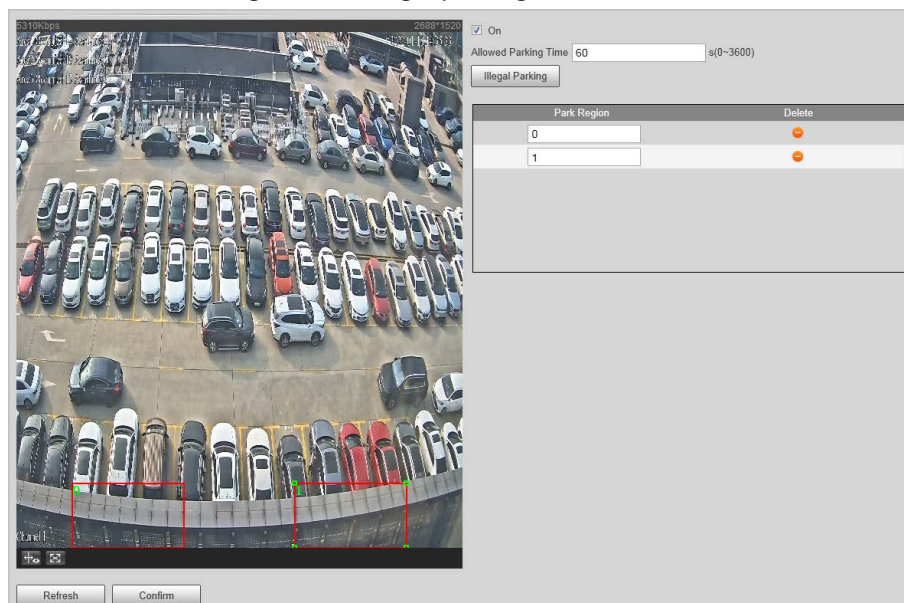

Step 5 Click **Confirm**.

## Related Operations

Click  to delete a parking region.

### 5.4.1.3 OSD Configuration

Set the OSD (On-screen Display) information to appear on videos and images.

#### 5.4.1.3.1 Video OSD

Set OSD information for a video channel.

Step 1 Select **Setting > ITC > OSD > Video OSD**.

Step 2 Click **Channel Title**, and then select **On** to enable the corresponding OSD type.  
The Camera supports adding information such as the channel, time, parking space and customized content as OSD.



In this section, **Channel Title** is used as an example.

Step 3 Set the channel title and its coordinates.

You can also drag the yellow frame to change the position of channel title.

Figure 5-19 Video OSD

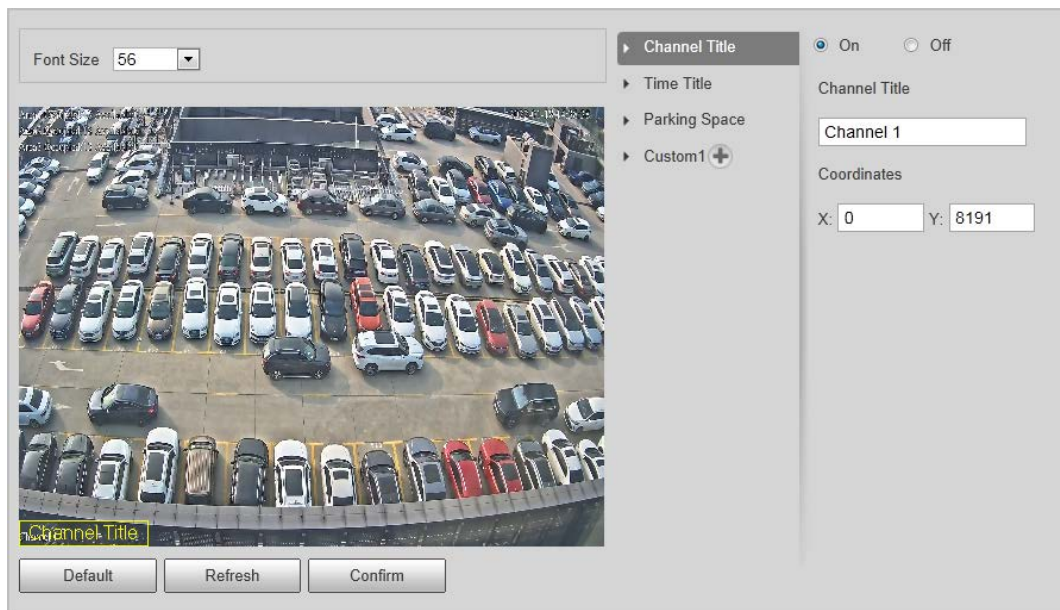

Step 4 (Optional) Click  next to **Custom1** to add more customized OSD information.



The system supports up to 2 customized OSD.

Step 5 Click **Confirm**.

#### 5.4.1.3.2 Snapshot OSD

You can set OSD information for pictures.

Step 1 Select **Setting > ITC > OSD > Snapshot OSD**.

Step 2 Move the title box to set its position on the snapshot, or manually enter coordinates into

the X/Y box at the lower-right corner of the page.

Figure 5-20 Snapshot OSD

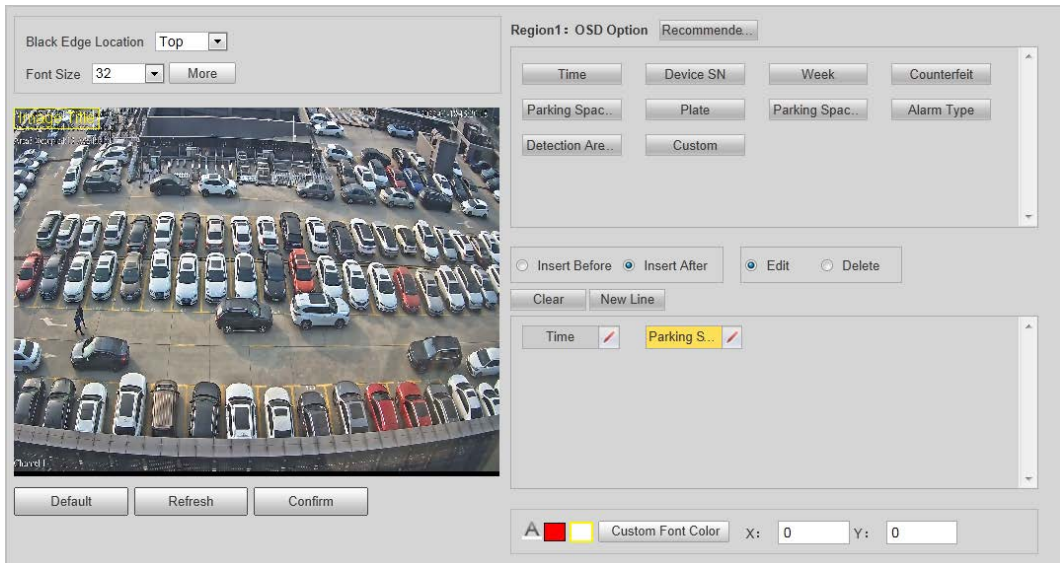

- Step 3** Select **Black Edge Location**, and then you can set the position of the OSD black strip. You can select from **Top**, **Bottom**, and **None**.
- Step 4** Set the OSD font.
- Select a font size from the list, click **More**, you can set the content separator.



You can manually enter other separators when selecting **Custom** from **Osd Separator**.

Figure 5-21 New line and OSD separator

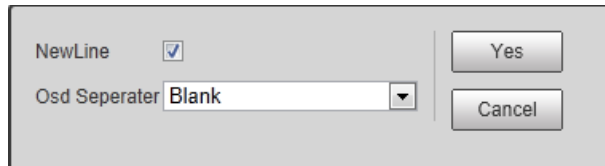

- Set the font color in . Click **Custom Font Color** to select from more colors.

**Step 5** Set OSD options.

Table 5-10 Snapshot OSD description

Parameter	Description
Recommended	Click to use the recommended configuration for snapshot OSD.
Insert Before	Select one OSD option, click <b>Insert Before</b> , and select other OSD options. The new OSD options will be displayed before the original OSD option.
Insert After	Select one OSD option, click <b>Insert After</b> , and select other OSD options. The new OSD option will be displayed after the original OSD option.
Edit	Click it, and all the OSD information status is displayed as  except <b>New Line</b> . Click  to modify the prefix, suffix, content, and separator of the corresponding OSD option.
Delete	Click it, and all the selected OSD information status is displayed as . Click  to delete the corresponding OSD option.

Parameter	Description
Clear	Delete all the OSD information.
New Line	After selecting some OSD information, click <b>New Line</b> , and the OSD information inserted after <b>NewLine</b> will be displayed in a new line on the picture.

Step 6 Click **Confirm**.

## 5.4.2 Camera

You can configure image, video, and stream parameters.

### 5.4.2.1 Camera Attribute

You can adjust the brightness, contrast, saturation of the video image, and set shutter parameters to get clear videos, and recordings that you want.

#### 5.4.2.1.1 General

This section provides guidance on configuring parameters such as image brightness, contrast, saturation, and hue.

Step 1 Select **Setting > Camera > Camera Attribute > General**.

Figure 5-22 General settings

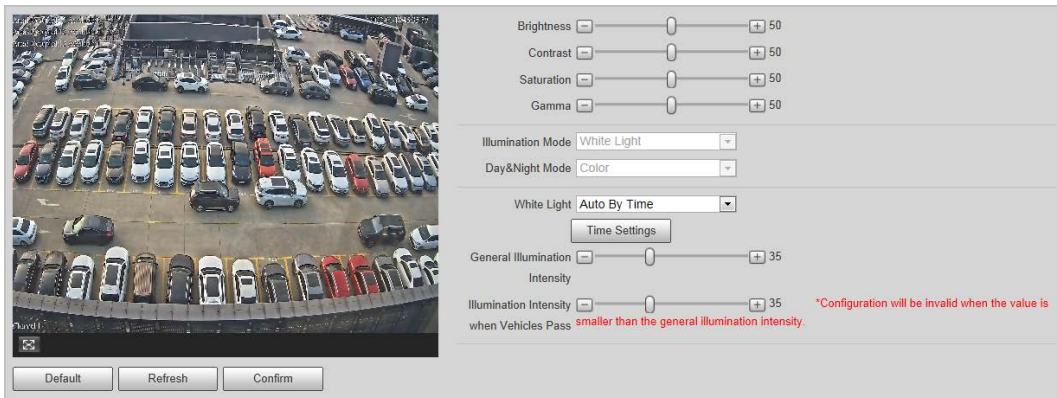

Step 2 Configure parameters.

Table 5-11 General parameters description

Parameter	Description
Brightness	<ul style="list-style-type: none"> <li>Adjust the overall image brightness. The bright and dark areas will have equal changes when adjusting the value.</li> <li>The image becomes blurry when the value is too big. The recommended value is from 40 to 60.</li> <li>The bigger the value, the brighter the image.</li> </ul>

Parameter	Description
Contrast	<p>Change the value when the image brightness is proper but contrast is not enough.</p> <ul style="list-style-type: none"> <li>• If the value is too big, the dark area is likely to become darker, and the bright area is likely to be overexposed.</li> <li>• The picture might be blurry if the value is too low. The recommended value is from 40 to 60.</li> <li>• The higher the value, the more obvious the contrast between the bright area, and dark area.</li> </ul>
Saturation	<p>Adjust the color vividness, and it will not influence the image overall brightness.</p> <ul style="list-style-type: none"> <li>• The image becomes too flamboyant if the value is too high.</li> <li>• The recommended value is from 40 to 60.</li> <li>• The higher the value, the more flamboyant the image.</li> </ul>
Gamma	Adjust the image brightness level. The higher the value, the brighter and blurry the image.
White Light	Select the illumination mode of the white light from <b>Always On</b> , <b>Always Off</b> , <b>Auto by Brightness</b> and <b>Auto by Time</b>
General Illumination Intensity	Set the illumination intensity when there are no vehicles passing.
Illumination Intensity when Vehicles Pass	Set the illumination intensity when there are vehicles passing.
Brightness Prevalue	<p>Set a prevalue of brightness. The Camera adjusts the brightness automatically based on the prevalue.</p>  <p>Only available when setting <b>White Light</b> mode to <b>Auto by Brightness</b></p>
Time Settings	Set the time period when the white light illuminates.

- 1) Click **Time Settings**.
- 2) Drag on the time table to select illumination periods for each day.  
The selected periods can be refined by clicking **Setting** next to the day, and then change the time on the lower section.

Figure 5-23 Time settings

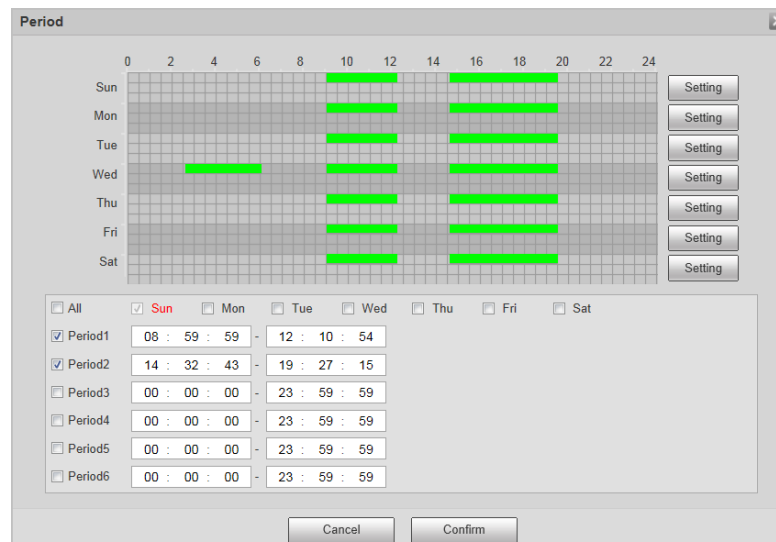

3) Click **Confirm**.

Step 3 Click **Confirm**.

### 5.4.2.1.2 Advanced Attributes

This section provides guidance on configuring advanced attributes, including exposure mode, shutter mode, white balance and scene mode.

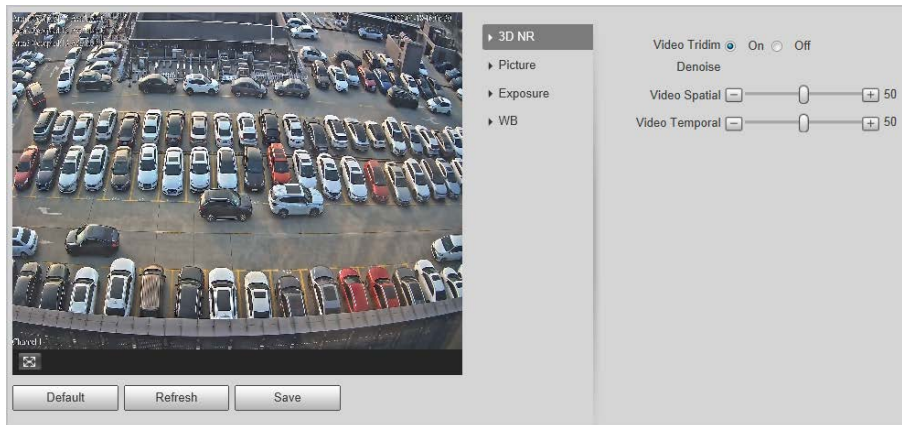

Step 1 Select **Setting > Camera > Camera Attribute > Advanced**.

Figure 5-24 Advanced attributes



Step 2 Configure parameters.

Table 5-12 Advanced parameters description

Parameter		Description
3D NR	Video Tridim Denoise	When it is <b>On</b> , 3D NR is enabled to reduce noise of video.
	Video Spatial	Spatial video denoising. The higher the value, the fewer the noise.
	Video Temporal	Temporal video denoising. The higher the value, the fewer the flicker noise.
Picture	Scene	You can change the scene, and adjust the sharpness of corresponding scene. Scenes available: <b>Dawn/Dusk, Daytime, and Night</b> .
	Sharpness	You can set the sharpness of corresponding scene. The higher the value, the clearer the image. But there will be noise if sharpness is too high.
	BLC Mode	Select from <b>WDR, BLC, HLC</b> and <b>SSA</b> to adjust the picture effect.
Exposure	Mode	Select the way of adjusting exposure mode.
	Shutter	Set the shutter.  Available when setting <b>Mode</b> to <b>Manual</b> or <b>Shutter Priority</b> .
	Shutter Scope	Set the time range of shutter.  Available when <b>Mode</b> is set to <b>Manual</b> or <b>Shutter Priority</b> and <b>Customized Range</b> is set as <b>Shutter</b> .

Parameter		Description
	Gain Scope	Set the value range of gain.  Available when set <b>Mode</b> to <b>Manual</b> or <b>Gain Priority</b> .
WB	Mode	Set scene mode to adjust the image to its better status.

### 5.4.2.1.3 Metering Zone

This section provides guidance on setting the measure mode of metering zone.

Step 1 Select **Setting > Camera > Attribute > Metering Zone**.

Figure 5-25 Metering Zone

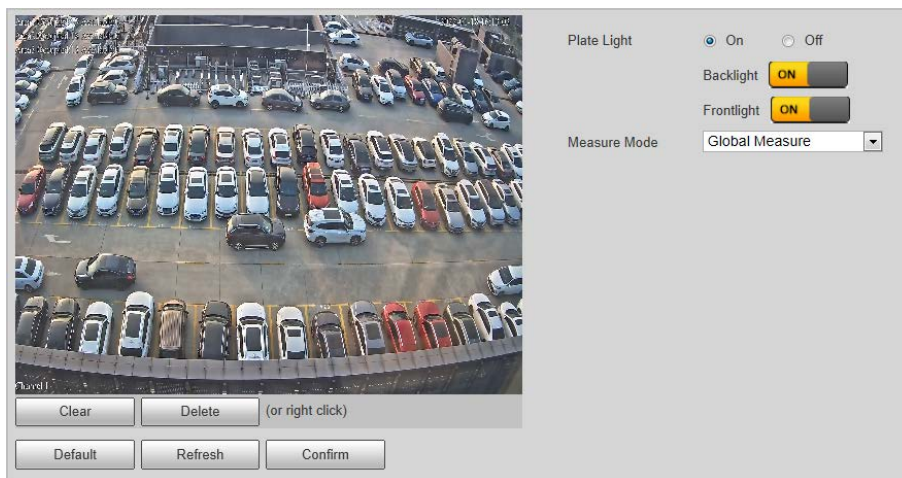

Step 2 Configure parameters.

Table 5-13 Metering zone parameter description

Parameter	Description
Plate Light	When selecting <b>Enable</b> , you can turn <b>ON</b> or <b>OFF</b> backlight, and frontlight according to scene requirement, and then improve the backlight image brightness.
Backlight	
Frontlight	
Measure Mode	<ul style="list-style-type: none"> <li>● <b>Global Measure</b>: Measure the brightness of the whole image area, and intelligently adjust the overall image brightness.</li> <li>● <b>Partial Measure</b>: Measure the brightness of sensitive area, and intelligently adjust the overall image brightness. If the measured area becomes bright, then the whole area becomes dark, and vice versa.</li> </ul>

Step 3 Click **Confirm**.

## 5.4.2.2 Video

### 5.4.2.2.1 Video

You can set the camera stream information.

Step 1 Select **Setting > Camera > Video > Video**.

Figure 5-26 Video

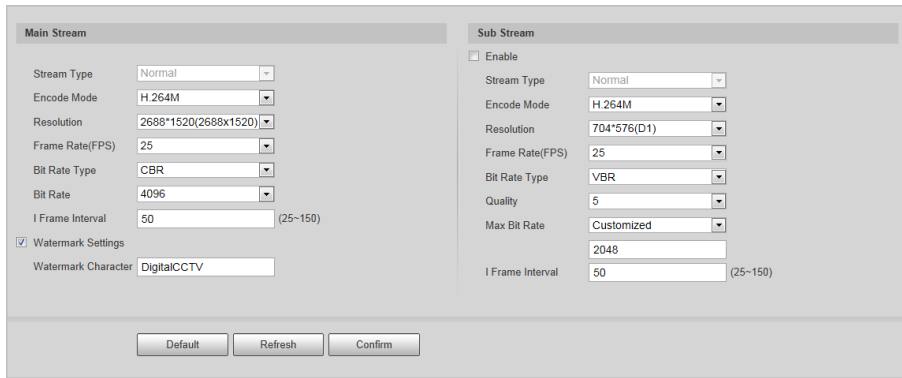

**Step 2** Configure parameters.

Table 5-14 Video parameters description

Parameter		Description
Main Stream	Stream Type	Currently it supports normal stream.
	Encode Mode	Currently it only supports H.264B, H.264M, H.264H, H.265, and MJPEG.
	Resolution	Select the resolution of the video.  The resolution of sub stream cannot be greater than main stream.
	Frame Rate(FPS)	Select frame rate as needed.
	Bit Rate Type	Include VBR, and CBR. Image quality can only be set in VBR mode.
	Bit Rate	The value is the upper limit of the stream in VBR mode while it is fixed in CBR mode.
	I Frame Interval	Frame or time interval between two I frames. The bigger the interval, the smaller space taken by the decompressed video. The system default is set twice as big as frame rate.
	Watermark Settings	You can view if the video is tampered through verifying watermark character. <ul style="list-style-type: none"> <li>• Select <b>Watermark Settings</b>, and enable the function.</li> <li>• <b>Watermark Character</b> is DigitalCCTV by default.</li> <li>• The watermark character can only consist of number, letter, underline, and maximum length contains 85 characters.</li> </ul>
Sub Stream	Enable	Select it, and enable sub stream.
	Quality	Image quality can be set in VBR mode. There are 6 levels optional.
	Max Bit Rate	The value is the upper limit of the stream in VBR mode while it is fixed in CBR mode.

**Step 3** Click **Confirm**.

### 5.4.2.2.2 Snapshot

You can set the picture stream, including resolution, quality or picture size.

Step 1 Select **Setting > Camera > Video > Snapshot**.

Figure 5-27 Snapshot

Step 2 Configure parameters.

Table 5-15 Snapshot parameters description

Parameter	Description
Snapshot Type	Currently it supports general snapshot.
Resolution	The snapshot resolution.
Image Size	It is in accordance with resolution value.
Quality	Set the snapshot quality which includes 6 levels optional.
Picture Coding Size (KB)	Select picture coding size from 8 options, or select <b>Custom</b> to define the size (50–1024).  You can only select one between picture quality and picture coding size to set the configuration.

Step 3 Click **Confirm**.

### 5.4.2.2.3 Region of Interest

Set the region of interest in the image, and then the selected image will display with configured quality.



- It supports max 3 regions at the same time.
- The image quality is displayed by level: **Worst, Worse, Bad, Good Better, or Best**.
- Click **Clear**, and delete all the area boxes; Select one box, and then click **Delete** or right-click to delete it.

Step 1 Select **Setting > Camera > Video > Interest Area**.

Figure 5-28 Interest area

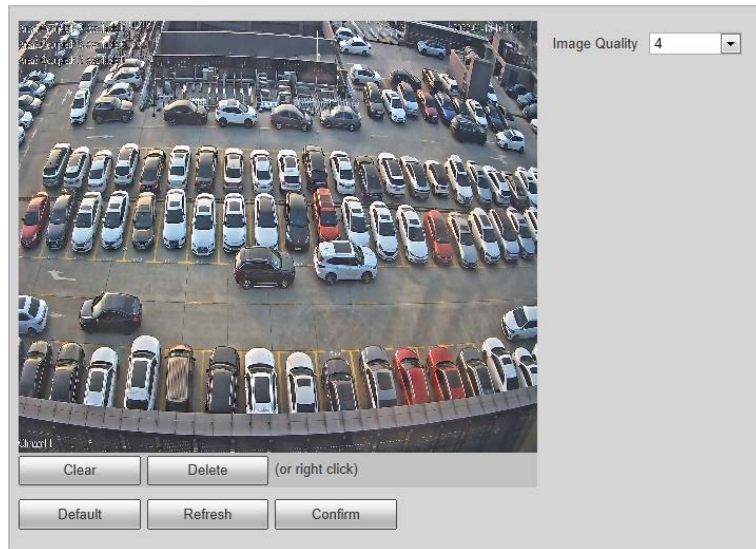

Step 2 Configure parameters.

Step 3 Click **Confirm**.

## 5.4.3 Network

You can set IP address, port, and other parameters.

### 5.4.3.1 TCP/IP

Configure the IP address of the Camera, and DNS server so that the Camera can connect with other devices in the network.



Some models support dual network port. Do not set them in the same network segment; otherwise it might cause network error.

Step 1 Select **Setting > Network > TCP/IP**.

Figure 5-29 TCP/IP

A screenshot of the TCP/IP configuration page. The form contains the following fields and values:

- Host Name: Camera
- Ethernet Card: Wire(Default)
- Mode:  Static  DHCP
- MAC Address: [blurred]
- IP Version: IPv4
- IP Address: 10 [blurred]
- Subnet Mask: 255 [blurred]
- Default Gateway: 10 [blurred]
- Preferred DNS: 8 [blurred]
- Alternate DNS: 8 [blurred]

At the bottom, there are two buttons: 'Refresh' and 'Confirm'.

**Step 2** Configure parameters.

Table 5-16 TCP/IP parameter description

Parameter	Description
Host Name	Enter a name (maximum 15 characters) for the host device.
Ethernet Card	Select the Ethernet card. The default setting is <b>Wire</b> .
Mode	Network mode, including static, and DHCP. <ul style="list-style-type: none"> <li>• <b>Static</b>: Manually set IP, subnet mask, and gateway.</li> <li>• <b>DHCP</b>: Automatically acquire IP. At this moment, IP, subnet mask, and gateway cannot be set.</li> </ul>
MAC Address	MAC address of the host.
IP Version	Includes <b>IPv4</b> , and <b>IPv6</b> . The IP address of both versions can be accessed.
IP Address	Device IP Address.
Subnet Mask	The corresponding subnet mask of device IP address.
Default Gateway	Corresponding gateway of device IP address.
Preferred DNS	IP address of DNS server.
Alternate DNS	Alternative IP address of DNS server.

**Step 3** Click **Confirm**.

### 5.4.3.2 Port

You can set the maximum number, and value of the ports.

**Step 1** Select **Setting > Network > Port**.

Figure 5-30 Port

The screenshot shows a configuration window with the following fields and values:

- Max Connection: 10 (range 1~20)
- TCP Port: 37777 (range 1025~65535)
- UDP Port: 37778 (range 1025~65534)
- HTTP Port: 80
- RTSP Port: 554
- HTTPS Port: 443

At the bottom, there are three buttons: Default, Refresh, and Confirm.

**Step 2** Configure each port value of the Camera.

Table 5-17 Connection parameters description

Parameter	Description
Max Connection	The maximum number of clients (such as web client, and platform client) that are allowed to access the Camera simultaneously. It is 10 by default.
TCP Port	Protocol communication port. It is 37777 by default.
UDP Port	User data packet protocol port. It is 37778 by default.
HTTP Port	HTTP communication port. It is 80 by default.

Parameter	Description
RTSP Port	Media streaming control port. It is 554 by default.
HTTPS Port	HTTPS communication port. It is 443 by default.

Step 3 Click **Confirm**.

### 5.4.3.3 Auto Register

Through auto register function, when the Camera is connected with external network, system will report its current location to the server so that client platform can access device through server.

Step 1 Select **Setting > Network > Auto Register > Auto Register**.

Step 2 Select **On** to enable the function.

Figure 5-31 Auto register

Step 3 Configure parameters.

Table 5-18 Auto register parameter description

Parameter	Description
Address	The IP address of the server on which the Camera register.
Port	The port of the server for auto registration.
Sub-Device ID	The device ID distributed by the server for auto registration. Make sure that the ID is unique during auto registration.

### 5.4.3.4 Platform

#### 5.4.3.4.1 ONVIF

You can enable the Open Network Video Interface Forum (ONVIF) function to make network video products of different manufacturers interworking.



ONVIF login authentication is enabled by default.

Step 1 Select **Setting > Network > Platform > ONVIF**.

Step 2 Select **Turn on**.

Figure 5-32 ONVIF

Step 3 Click **Confirm**.

### 5.4.3.4.2 Info Push Platform

You can configure this parameter to push the captured vehicle violations information to the server.

**Step 1** Select **Setting > Network > Platform > Info Push Platform**.

Figure 5-33 Information push configuration

**Step 2** Configure parameters.

Table 5-19 ITC push parameter description

Parameter	Description
Basic configuration	
Client	The client from which the pushed information comes.
Keep Alive Circle	Time interval (0–65535) of checking whether the Camera is connected with the set client.
Max Keep-alive Request	Set the number of requests the Camera sends to the set client in total. When the number exceeds the defined value, the Camera stops checking.
Upload Type	Select the information type that you want to upload.
Data Acquisition	
Data Type	Select the types of data to be acquired from the Camera.
Uploading Info	Select the types of information to be uploaded.
Picture Config	
Filter Condition	Select <b>No Plate</b> , the Camera filters out the records with no plate.

**Step 3** Click **Confirm**.

## 5.4.4 Event

This section provides guidance on configuring alarm, and abnormality.

## 5.4.4.1 Alarm

### 5.4.4.1.1 Relay Activation

You can set several parameters of relay activation such as relay-in, period, anti-dither, and sensor type. When triggering alarm, the system sends the alarm signal to external devices to trigger, for example, buzz.

**Step 1** Select **Setting > Event > Alarm > Relay Activation**.

**Step 2** Select **On** checkbox to enable alarm input for the current channel.

Figure 5-34 Relay activation

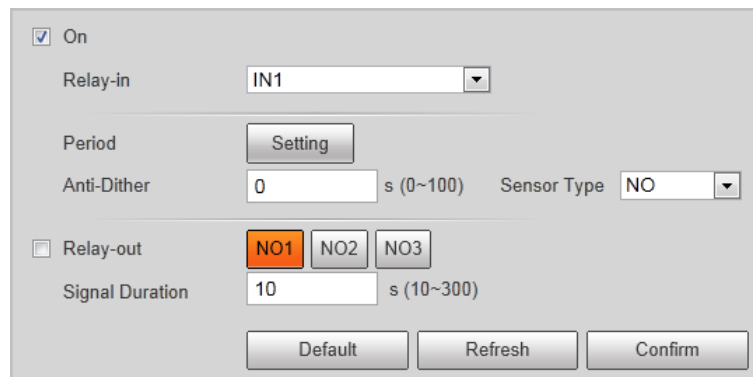

**Step 3** Select alarm input channel.

**Step 4** Set the period of alarm input.

1) Click **Time Settings**.

2) Drag on the time table to select illumination periods for each day.

The selected periods can be refined by clicking **Setting** next to the day, and then change the time on the lower section.



Select days to apply the settings to other days.

Figure 5-35 Time settings

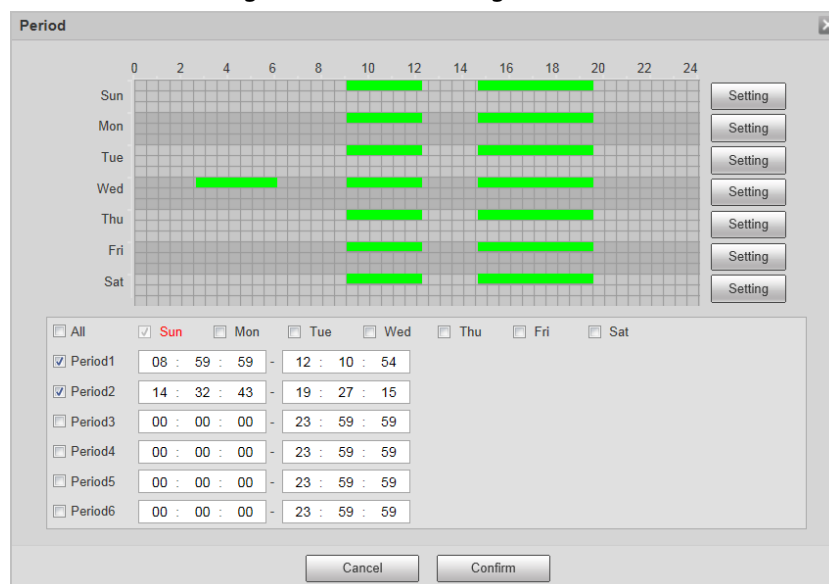

3) Click **Confirm**.

**Step 5** Set other parameters.

Table 5-20 Relay activation parameter

Parameter	Description
Anti-dither	Enter anti-dither time (1 s–100 s). System will only record one when there are multiple alarms during the defined time..
Sensor Type	Select relay-in type according to the connected alarm input device. <ul style="list-style-type: none"> <li>• <b>NO</b>: Low level valid.</li> <li>• <b>NC</b>: High level valid.</li> </ul>
Relay-out	Optocoupler output. Select the check box to activate corresponding alarm output device when alarm occurs.
Signal Duration	The time that delays alarm when alarm occurs.

Step 6 Click **Confirm**.

### 5.4.4.1.2 Relay-out

You can trigger one alarm output signal.

Step 1 Select **Setting > Event > Alarm > Relay-out**.

Step 2 Click **NO1**, **NO2** or **NO3** to set one alarm channel.

Step 3 Set alarm output.

- Click **Trigger** to output relay-out signal. For example, if the Camera connects with an external buzzer, when clicking **Trigger**, and the buzzer buzzes, meaning the alarm output works properly.
- Click **Refresh** to refresh alarm output status.

### 5.4.4.2 Abnormality

Set relay-out mode of different events. When abnormality happens, system triggers alarm.

Step 1 Select **Setting > Event > Abnormality**.

Step 2 Select events from SD card, network error, illegal access, and security exception as needed.

Figure 5-36 Event



Step 3 (Optional) Select event type. You only need to select this for SD card and network error.

Step 4 Select **On** to enable various abnormalities.

Step 5 Configure parameters of each event.

Table 5-21 Abnormality parameters description

Parameter	Description
Enable	Select to enable corresponding abnormality event.

Parameter	Description
Relay-out	Check to enable the corresponding alarm output of abnormality event, and select the corresponding port.
Signal Duration	The alarm linkage keeps running for the defined time after alarm ends. The time range is 10 s–300 s.
Capacity Limit	Configure the storage available that triggers abnormality alarm.  Only need to configure when setting <b>Event Type</b> to <b>Scarcity of Storage Space</b> .
Login Error	Configure the number of login error allowed. The range is 3–10 times.  Only need to configure when setting <b>Illegal Access</b> .

Step 6 Click **Confirm**.

## 5.4.5 Storage

This section provides guidance on setting associated information of storage, and record control.

### 5.4.5.1 Point

Set the storage path of snapshot.

Step 1 Select **Setting > Storage > Destination > Point**.

Step 2 Select **Local** as **Event Type** to store data into the TF card.

Figure 5-37 Point

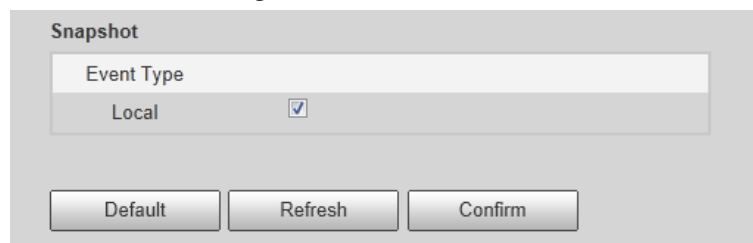

Step 3 Click **Confirm**.

### 5.4.5.2 Local

Display the information of local SD card. You can set hot swap, and format SD card.



Format the SD card before use.

Step 1 Select **Setting > Storage > Destination > Local**.

- Select **Overwrite** or **Stop** from **Disk Full**, meaning overwrite the records or stop storing new pictures or videos respectively when disk is full.
- View the storage information of the card.
- Click **Hot Swap**, and then you can pull out the SD card.

- Click **Format**, and then you can format the SD card.

Figure 5-38 Local configuration parameter description

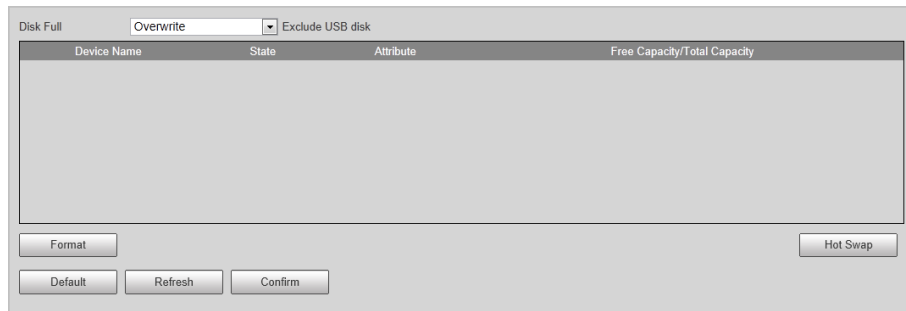

Step 2 Click **Confirm**.

### 5.4.5.3 Save Path

This section provides guidance on configuring picture, record naming, and storage path.

Step 1 Select **Setting > Storage > Destination > Save Path**.

Step 2 According to the actual requirements, set the naming rule of pictures. Click **Help...** for more details.

Step 3 Set the storage path for recordings and snapshots.

Step 4 Click **Confirm**.

## 5.4.6 System

You can configure general information, adding user, restoring default settings, and configuring import & export file.

### 5.4.6.1 General

#### 5.4.6.1.1 General Setup

This section provides guidance on configuring device SN, language, and video standard.

Step 1 Select **Setting > System > General Setting > General Setup**.

Step 2 Set the information of the Camera, including camera name, code, language displayed on the web client, video standard and company details.

Figure 5-39 General

Step 3 Click **Confirm**.

### 5.4.6.1.2 Date & Time

You can set date, time format, system time, DST (Daylight Saving Time) or NTP server, and more.

**Step 1** Select **Setting > System > General > Date&Time**.

**Step 2** Set the format of time and date, time zone and DST information.

Figure 5-40 Date & time

The screenshot shows a configuration window for Date & Time. It contains the following elements:

- Date Format: YYYY-MM-DD
- Time Format: 24-Hour
- Time Zone: (UTC+08:00) Beijing, Chongqing, Hong Kong
- System Time: 2022-01-18 16 : 48 : 02
- DST:  DST
- DST Type:  Date  Week
- Begin Time: Jan 1st Mon 00 : 00 : 00
- End Time: Jan 1st Tue 00 : 00 : 00
- NTP Setting:  NTP Setting
- NTP Server: clock.isc.org
- Port: 123
- Interval: 10 minute(s) (1~30)
- Buttons: Default, Refresh, Confirm

**Step 3** Click **Sync PC** to synchronize the Camera time with the server.

**NTP Setting** is necessary for the time synchronization.

**Step 4** Click **Confirm**.

## 5.4.6.2 Account

### 5.4.6.2.1 User Account

You can create accounts that can operate on the Camera through the web client.



- It is recommended to give fewer authorities to normal users than premium users.
- Cannot delete an account when it is in login status.

#### Procedure

**Step 1** Select **Setting > System > Account > Account**.

**Step 2** Select **Group Name** tab, and then click **Add Group**.

**Step 3** Enter the name of user group, and configure group authority.

- **Group Name** can only consist of number, letter, underscore, and hyphen, the maximum length contains 15 characters.
- **Group Name** cannot be repeated.

Figure 5-41 Add group

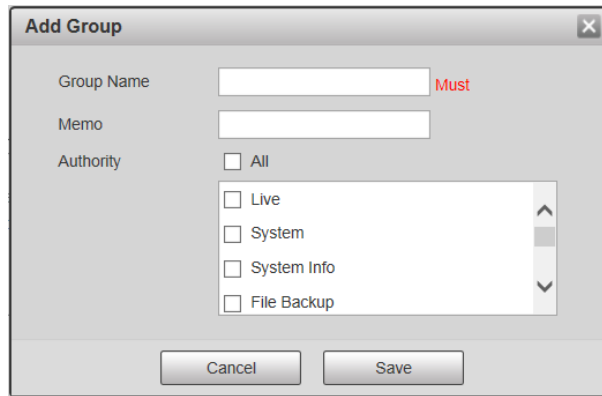

**Step 4** Click **Save**.



Up to 8 user groups can be created, and the default user groups are **admin** and **user**.

**Step 5** Select **Username** tab, and then click **Add User**.

**Step 6** Set username and password, select a user group for the account.

**Step 7** Under **Operation Permission** section, select the permissions you want to assign to the account.

**Step 8** Click **Restricted Login**, set login restrictions for the account.

- 1) Set the IP address to which the account has no access.
- 2) Set the period during which the account cannot access the set IP.
- 3) Set specific time periods of the restriction.

Figure 5-42 Add user

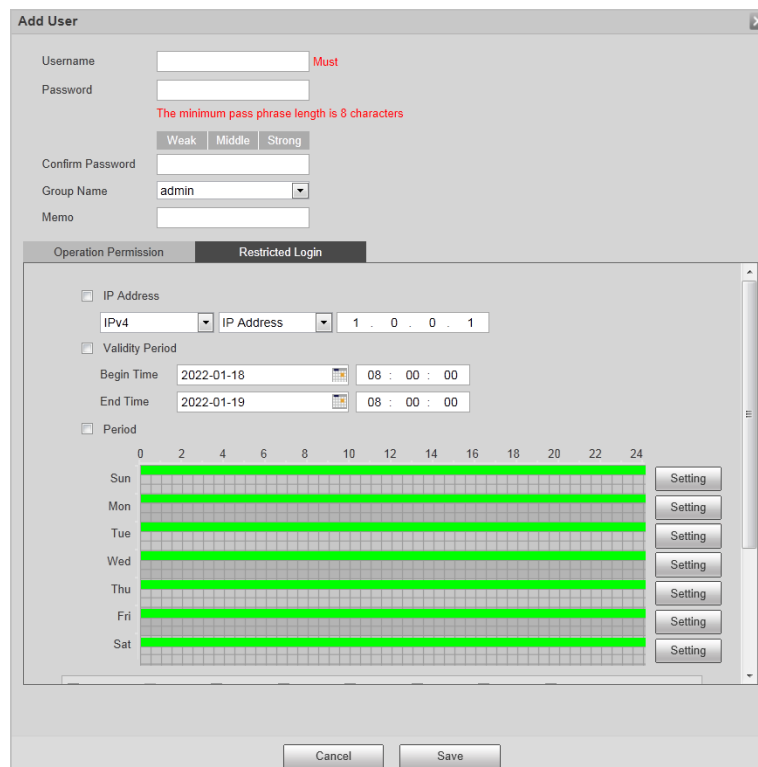

4) Click **Save**.

## Related Operations

- Click  to change user/group information

- Click  to delete the added user/group.



Admin user/group cannot be deleted.

### 5.4.6.2.2 ONVIF User

You can add, delete, modify ONVIF users.

Step 1 Select **Setting > System > Account > Onvif User**.

Step 2 Click **Add User**.

Figure 5-43 Add user

Step 3 Set the name and password of the account, and then select a user group.

Step 4 Click **Save**.

## 5.4.6.3 Safety

### 5.4.6.3.1 System Service

Select to enable system services as needed.

Step 1 Select **Setting > System > Safety > System Service**.

Figure 5-44 System Service

Step 2 Select needed system services.

Table 5-22 System service parameters description

Parameter	Description
SSH	SSH (Secure Shell) implements data encrypted transmission, and effectively avoids information leakage during remote management.
Multicast/Broadcast Search	<ul style="list-style-type: none"> <li>• <b>Multicast:</b> It realizes point-to-multipoint network connection between sender and receiver.</li> <li>• <b>Broadcast Search:</b> Broadcast data packet in IP subnet, all the hosts in the subnet will receive these data packets.</li> </ul>
Password Reset	When you forget the password of admin user, you can set new password through password reset function.
CGI Service	CGI is the port between external application program, and web server.
Onvif Service	Realizes network video framework agreement to make different network video products interconnected.
Audio and Video Transmission Encryption	Enable this function to encrypt streams transmitted through private protocols.
RTSP over TLS	Enable this function to encrypt stream transmitted through standard protocol. It is recommended to keep the function on.
Private Protocol Authentication Mode	Keep the recommended <b>Security Mode</b> .

Step 3 Click **Confirm**.

### 5.4.6.3.2 HTTPS

#### Prerequisites

- For first-time use of HTTPS or after changing device IP address, you need to create server certificate, and install root certificate.
- After creating server certificate, and installing root certificate, if you change a computer to log in to the web client, then you need to download and install the root certificate again on the new computer or copy the downloaded root certificate on the new computer, and install it.

On the **HTTPS** page, users can make PC log in normally through HTTPS by creating certificate or uploading authenticated certificate. It can ensure security of communication data, and provide guarantee for user information, and device safety through reliable, and stable technical approach.

#### Procedure

Step 1 Create certificate or upload the authenticated certificate.

- **Create Certificate.**
  1. Select **Setting > System > Safety > HTTPS**.

Figure 5-45 HTTPS

Enable HTTPS

**TLS Protocol Compatibility**

Compatible with TLSv1.1 and earlier versions

**Create Certificate**

**Request Created**

Request Created

**Install Signed Certificate**

Certificate Path

Certificate Key Path

**Certificate Installed**

Certificate Installed

Attribute

2. Click **Create**.

Figure 5-46 HTTPS

**HTTPS**

Region  \*e.g. CN

IP or Domain name  \*

Validity Period  Day\*Range :1-5000

Province

Location

Organization

Organization Unit

Email

3. Enter the required information such as region, IP or domain name, and then click **Create**.



The entered **IP or Domain name** must be the same as the IP or domain name of the **Camera**.

4. Click **Install** under **Request Created**, and then click **Download** to download root certificate.  
The system pops up **Save As** dialog box, select storage path, and then click **Save**.
5. Double-click the RootCert.cer icon.
6. Click **Install Certificate...**

Figure 5-47 Install certificate

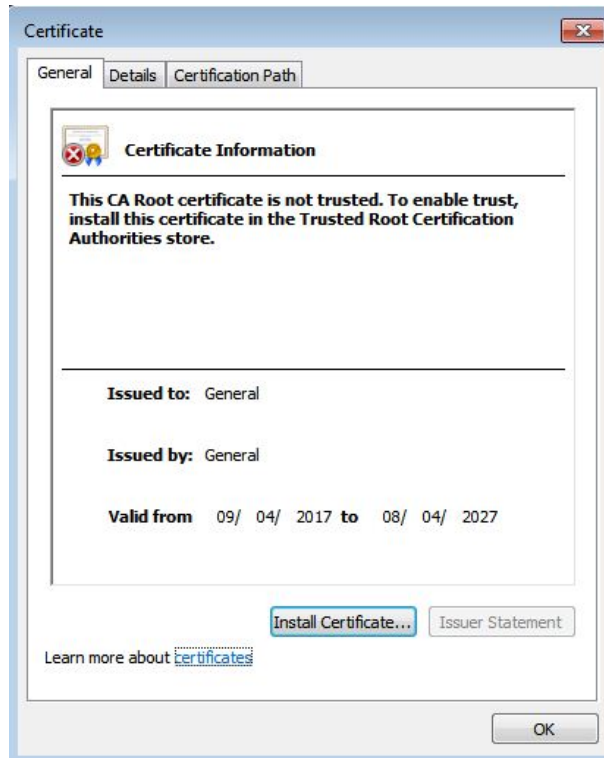

7. Click **Next**.

Figure 5-48 Certificate store

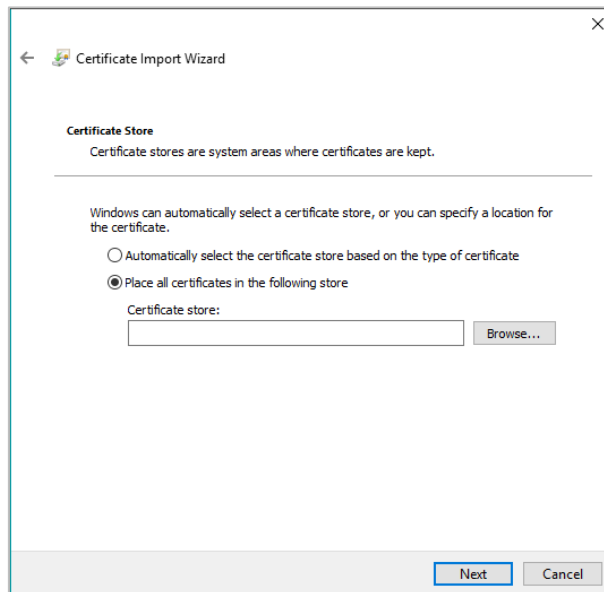

8. Click **Next**.

Figure 5-49 Completing certificate import wizard

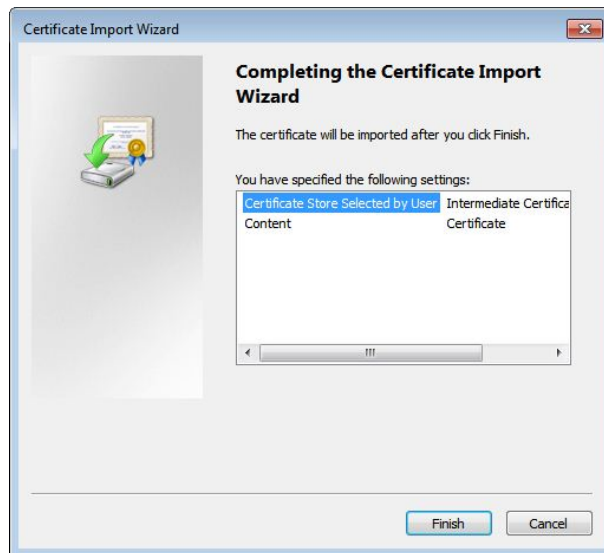

9. Click **Finish**.

Figure 5-50 Security warning

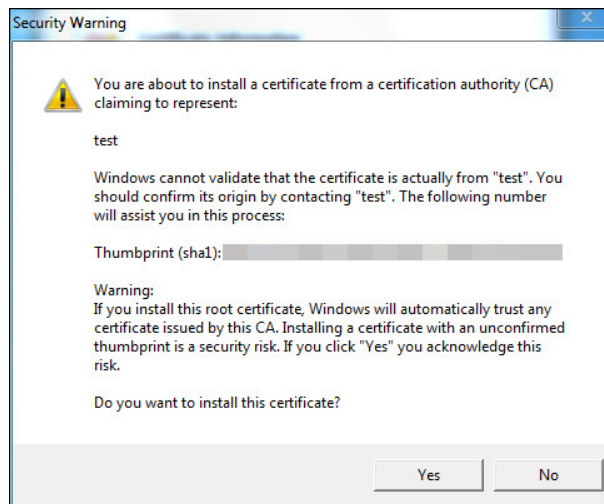

10. Click **Yes**, and then click **OK** on the pop-up window.

- **install signed certificate.**

1. Select **Setting Safety > System > Safety > HTTPS**.
2. Select **Enable HTTPS**, and **Compatible with TLSv1.1 and earlier versions**.
3. Click **Browse** to upload the signed certificate, and certificate key, and then click **Upload**.
4. To install the root certificate, see operation steps from 4 to 10 in **Create Certificate**.

Step 2 Select **Enable HTTPS**, and click **Confirm**.

The configuration takes effect until the Camera restarts.

Step 3 Use HTTPS to log in to the Camera.

1. Enter `https://xx.xx.xx.xx` in the browser.



`xx.xx.xx.xx` is the Camera IP address or domain name.

2. Enter the username, and password to log in to the Camera.

### 5.4.6.3.3 Firewall

Set the security rules to protect the safety of your camera system.

Step 1 Select **Setting** > **System** > **Safety** > **Firewall**.

Figure 5-51 Firewall

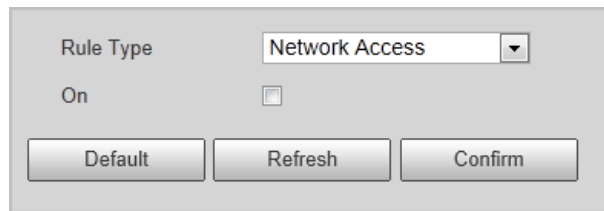

Step 2 Select **Rule Type**.

- **Network Access:** Add the IP address to allowlist or blocklist to allow or restrict it to access corresponding ports of the Camera.
- **PING Prohibited:** IP address of your camera is prohibited from ping. This helps prevent attempt of accessing your network system without permission.
- **Prevent Semijoin:** Prevents half-open SYN attacks.

Step 3 Select **On** to enable the selected rule type.

Step 4 Click **Confirm**.

### 5.4.6.4 Default Settings

You can restore the Camera to default settings or factory defaults.

Select **Setting** > **System** > **Default**, and then select **Default** or **Factory Default** as needed.

- **Default:** Restore your settings except the IP address to the default.
- **Factory Default:** Restore the system to factory default settings. In this case, the Camera will restart, and you need to initialize the Camera before any further operation.

### 5.4.6.5 Import/Export

Export the system configuration file to back up the system configuration; import system configuration file to make quick configuration or recover system configuration.

Step 1 Select **Setting** > **System** > **Import/Export**.

Figure 5-52 Import/Export

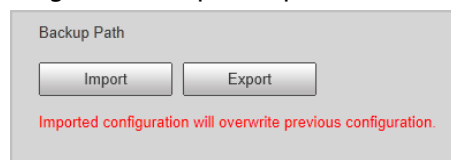

Step 2 Click **Import** or **Export**.

- **Import:** Import the local system configuration file to the system.
- **Export:** Export associated configuration to local, and save as file whose suffix is .backup.

Step 3 Select the imported file path or exported folder.

Step 4 Click **Open** or **Save**, and view import, and export result on the web page.

## 5.4.6.6 Automatic Maintenance

You can set the time of auto reboot, and automatically delete old files.

Step 1 Select **Setting > System > Auto Maintain**.

Figure 5-53 Auto maintain

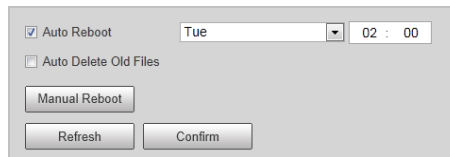

Step 2 Select **Auto Reboot**, and then set the restart time.

Step 3 Select **Auto Delete Old Files**, and then set a time point, and all the old files before this time will be deleted.

Step 4 (Optional) Click **Manual Reboot** can restart the Camera immediately.

Step 5 Click **Confirm**.

## 5.4.6.7 Update

Step 1 Select **Setting > System Upgrade > System Upgrade**.



The pages might vary depending on the Camera model.

Figure 5-54 Upgrade

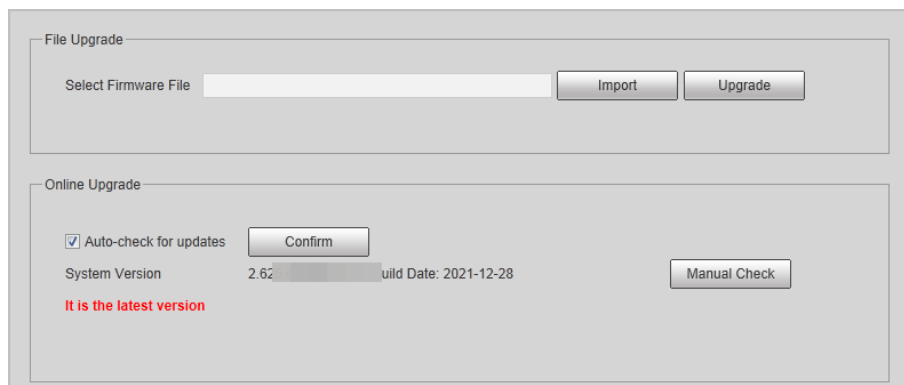

Step 2 Click **Import** to select the update file, and then click **Upgrade** to update the system.



Do not disconnect the power or network, or restart or shut down the Camera during update. Incorrect update programs might result in malfunctions of the Camera.

## 5.4.7 Information

You can view version, user, and log, and more.

### 5.4.7.1 Version

You can view the version information of the Camera.

Select **Setting > System Info > Version**.



- Versions might vary depending on the actual device.
- Algorithm recognition is available when algorithm is authorized (when the icon is displayed in green). If algorithm is not authorized, the Camera will not be able to recognize vehicle series, model, and logo. License plate recognition is always supported.

Figure 5-55 Version

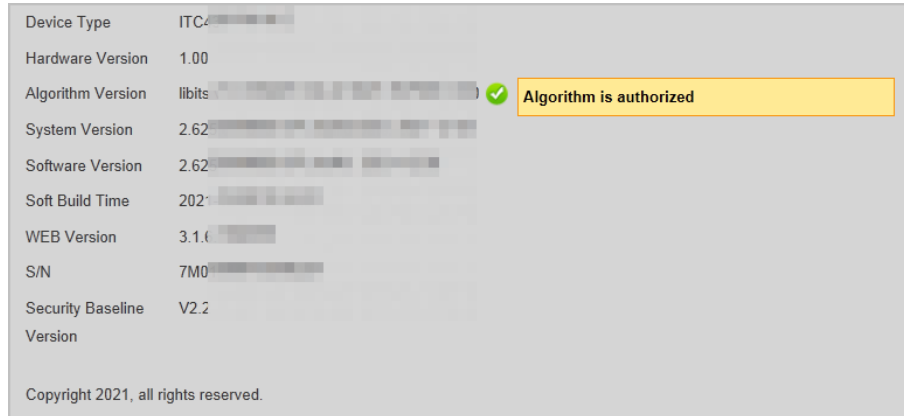

## 5.4.7.2 Log

### 5.4.7.2.1 System Log

You can view log information such as system, configuration, data, event, record, user management, and also clear log records.



The earliest log records will be overwritten when the number of log records reaches 1024.

**Step 1** Select **Setting > System Info > Log > Log**.

**Step 2** Set search conditions, and then click **Search**.

Figure 5-56 Log

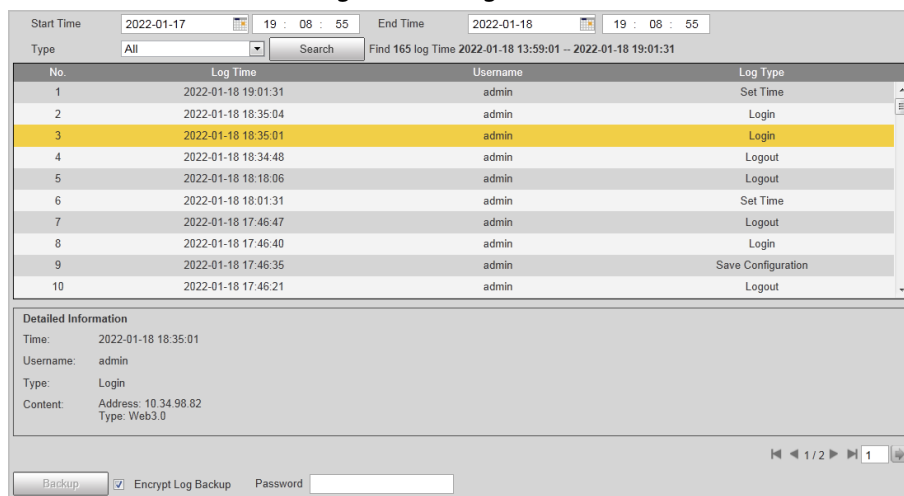

**Step 3** Select one log, you can view the details in the lower section.

**Step 4** (Optional) Select **Encrypt Log Backup**, set the password and then click **Backup** to export all encrypted logs to local computer.

### 5.4.7.2 Remote log

You can save your important logs to log server. This helps provide important clues to the source of security incidents. Log server needs to be deployed in advance by a professional or system administrator.

Step 1 Select **Setting > System Info > Log > Remote Log**.

Step 2 Select **On** to enable remote log.

Step 3 Enter the IP address, port, and device number of the Camera for the server to read log data.

Step 4 Click **Confirm**.

### 5.4.7.3 Online User

Step 1 Select **Setting > System Info > Online User** to view the information of all the online users.

Step 2 Click **Refresh** to view the latest status.

### 5.4.7.4 Legal Information

Select **Setting > System Info > Legal Info** to view the **Open Source Software Notice**.

## 5.5 Alarm

Step 1 Click the **Alarm** tab

Step 2 Select alarm type, operation, and alarm tone.

After selecting alarm type, the Camera displays alarms that conform to the selected types on the right side.

Figure 5-57 Alarm

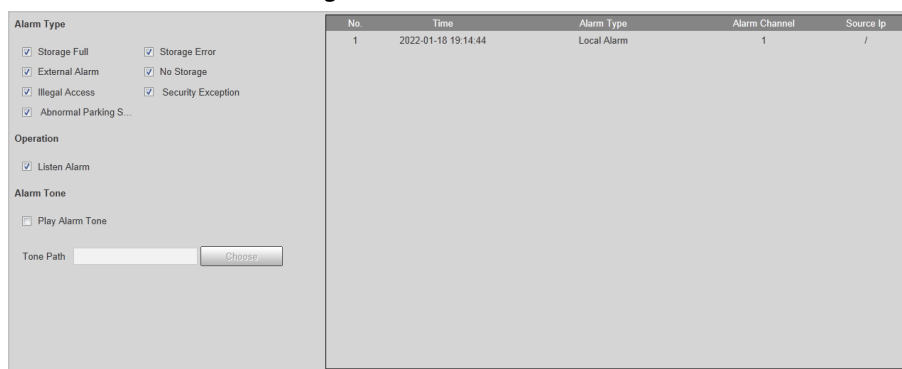

## 5.6 Logout

Click **Logout** to exit the web client.

# Appendix 1 Cybersecurity Recommendations

## **Mandatory actions to be taken for basic equipment network security:**

### **1. Use Strong Passwords**

Please refer to the following suggestions to set passwords:

- The length should not be less than 8 characters.
- Include at least two types of characters; character types include upper and lower case letters, numbers and symbols.
- Do not contain the account name or the account name in reverse order.
- Do not use continuous characters, such as 123, abc, etc.
- Do not use overlapped characters, such as 111, aaa, etc.

### **2. Update Firmware and Client Software in Time**

- According to the standard procedure in Tech-industry, we recommend to keep your equipment (such as NVR, DVR, IP camera, etc.) firmware up-to-date to ensure the system is equipped with the latest security patches and fixes. When the equipment is connected to the public network, it is recommended to enable the “auto-check for updates” function to obtain timely information of firmware updates released by the manufacturer.
- We suggest that you download and use the latest version of client software.

## **"Nice to have" recommendations to improve your equipment network security:**

### **1. Physical Protection**

We suggest that you perform physical protection to equipment, especially storage devices. For example, place the equipment in a special computer room and cabinet, and implement well-done access control permission and key management to prevent unauthorized personnel from carrying out physical contacts such as damaging hardware, unauthorized connection of removable equipment (such as USB flash disk, serial port), etc.

### **2. Change Passwords Regularly**

We suggest that you change passwords regularly to reduce the risk of being guessed or cracked.

### **3. Set and Update Passwords Reset Information Timely**

The device supports password reset function. Please set up related information for password reset in time, including the end user’s mailbox and password protection questions. If the information changes, please modify it in time. When setting password protection questions, it is suggested not to use those that can be easily guessed.

### **4. Enable Account Lock**

The account lock feature is enabled by default, and we recommend you to keep it on to guarantee the account security. If an attacker attempts to log in with the wrong password several times, the corresponding account and the source IP address will be locked.

### **5. Change Default HTTP and Other Service Ports**

We suggest you to change default HTTP and other service ports into any set of numbers between 1024–65535, reducing the risk of outsiders being able to guess which ports you are using.

### **6. Enable HTTPS**

We suggest you to enable HTTPS, so that you visit Web service through a secure communication channel.

### **7. MAC Address Binding**

We recommend you to bind the IP and MAC address of the gateway to the equipment, thus

reducing the risk of ARP spoofing.

#### **8. Assign Accounts and Privileges Reasonably**

According to business and management requirements, reasonably add users and assign a minimum set of permissions to them.

#### **9. Disable Unnecessary Services and Choose Secure Modes**

If not needed, it is recommended to turn off some services such as SNMP, SMTP, UPnP, etc., to reduce risks.

If necessary, it is highly recommended that you use safe modes, including but not limited to the following services:

- SNMP: Choose SNMP v3, and set up strong encryption passwords and authentication passwords.
- SMTP: Choose TLS to access mailbox server.
- FTP: Choose SFTP, and set up strong passwords.
- AP hotspot: Choose WPA2-PSK encryption mode, and set up strong passwords.

#### **10. Audio and Video Encrypted Transmission**

If your audio and video data contents are very important or sensitive, we recommend that you use encrypted transmission function, to reduce the risk of audio and video data being stolen during transmission.

Reminder: encrypted transmission will cause some loss in transmission efficiency.

#### **11. Secure Auditing**

- Check online users: we suggest that you check online users regularly to see if the device is logged in without authorization.
- Check equipment log: By viewing the logs, you can know the IP addresses that were used to log in to your devices and their key operations.

#### **12. Network Log**

Due to the limited storage capacity of the equipment, the stored log is limited. If you need to save the log for a long time, it is recommended that you enable the network log function to ensure that the critical logs are synchronized to the network log server for tracing.

#### **13. Construct a Safe Network Environment**

In order to better ensure the safety of equipment and reduce potential cyber risks, we recommend:

- Disable the port mapping function of the router to avoid direct access to the intranet devices from external network.
- The network should be partitioned and isolated according to the actual network needs. If there are no communication requirements between two sub networks, it is suggested to use VLAN, network GAP and other technologies to partition the network, so as to achieve the network isolation effect.
- Establish the 802.1x access authentication system to reduce the risk of unauthorized access to private networks.
- Enable IP/MAC address filtering function to limit the range of hosts allowed to access the device.