

# Ruijie Reyee RG-NBS3100-24GT4SFP, NBS3100-24GT4SFP-P, NBS3100-8GT2SFP, NBS3100-8GT2SFP-P Series Switches

## Installation Guide



## Copyright

Copyright © 2024 Ruijie Networks

All rights are reserved in this document and this statement.

Without the prior written consent of Ruijie Networks, any organization or individual shall not reproduce, extract, back up, modify, or propagate the content of this document in any manner or in any form, or translate it into other languages or use some or all parts of the document for commercial purposes.

 and other Ruijie networks logos are trademarks of Ruijie Networks.

All other trademarks or registered trademarks mentioned in this document are owned by their respective owners.

## Disclaimer

The products, services, or features you purchase are subject to commercial contracts and terms, and some or all of the products, services, or features described in this document may not be available for you to purchase or use. Except for the agreement in the contract, Ruijie Networks makes no explicit or implicit statements or warranties with respect to the content of this document.

The names, links, descriptions, screenshots, and any other information regarding third-party software mentioned in this document are provided for your reference only. Ruijie Networks does not explicitly or implicitly endorse or recommend the use of any third-party software and does not make any assurances or guarantees concerning the applicability, security, or legality of such software. You should choose and use third-party software based on your business requirements and obtain proper authorization. Ruijie Networks assumes no liability for any risks or damages arising from your use of third-party software.

The content of this document will be updated from time to time due to product version upgrades or other reasons, Ruijie Networks reserves the right to modify the content of the document without any notice or prompt.

This manual is designed merely as a user guide. Ruijie Networks has tried its best to ensure the accuracy and reliability of the content when compiling this manual, but it does not guarantee that the content of the manual is completely free of errors or omissions, and all the information in this manual does not constitute any explicit or implicit warranties.

# Preface

## Intended Audience

This document is intended for:

- Network engineers
- Technical support and servicing engineers
- Network administrators

## Technical Support

- The official website of Ruijie Reyee: <https://reyee.ruijie.com>
- Technical Support Website: <https://reyee.ruijie.com/en-global/support>
- Case Portal: <https://www.ruijienetworks.com/support/caseportal>
- Community: <https://community.ruijienetworks.com>
- Technical Support Email: [service\\_rj@ruijienetworks.com](mailto:service_rj@ruijienetworks.com)
- Online Robot/Live Chat: <https://reyee.ruijie.com/en-global/rita>

## Conventions

### 1. Signs

This document also uses signs to indicate some important points during the operation. The meanings of these signs are as follows:

---

#### Caution

An alert that calls attention to safety instruction that if not understood or followed can result in personal injury.

---

#### Warning

An alert that calls attention to important rules and information that if not understood or followed can result in data loss or equipment damage.

---

#### Note

An alert that calls attention to essential information that if not understood or followed can result in function failure or performance degradation.

---

#### Instruction

An alert that contains additional or supplementary information that if not understood or followed will not lead to serious consequences.

---

#### Specification

An alert that contains a description of product or version support.

---

## **2. Note**

This manual provides installation steps, troubleshooting, technical specifications, and usage guidelines for cables and connectors. It is intended for users who want to understand the above and have extensive experience in network deployment and management, and assume that users are familiar with related terms and concepts.

# Contents

|   |    |
|---|----|
| Preface .....                           | 1  |
| 1 Product Overview .....                | 1  |
| 1.1 RG-NBS3100-24GT4SFP .....           | 1  |
| 1.1.1 Technical Specifications .....    | 1  |
| 1.1.2 Product Appearance .....          | 2  |
| 1.1.3 Heat Dissipation .....            | 4  |
| 1.1.4 LED .....                         | 4  |
| 1.2 RG-NBS3100-24GT4SFP-P .....         | 4  |
| 1.2.1 Technical Specifications .....    | 4  |
| 1.2.2 Product Appearance .....          | 6  |
| 1.2.3 Heat Dissipation .....            | 7  |
| 1.2.4 LED .....                         | 8  |
| 1.3 RG-NBS3100-8GT2SFP .....            | 9  |
| 1.3.1 Technical Specifications .....    | 9  |
| 1.3.2 Product Appearance .....          | 10 |
| 1.3.3 Heat Dissipation .....            | 11 |
| 1.3.4 LED .....                         | 11 |
| 1.4 RG-NBS3100-8GT2SFP-P .....          | 12 |
| 1.4.1 Technical Specifications .....    | 12 |
| 1.4.2 Product Appearance .....          | 13 |
| 1.4.3 Heat Dissipation .....            | 15 |
| 1.4.4 LED .....                         | 15 |
| 2 Preparation before Installation ..... | 17 |

|  |    |
|--|----|
| 2.1 Safety Suggestions .....                               | 17 |
| 2.1.1 Installation .....                                   | 17 |
| 2.1.2 Movement .....                                       | 17 |
| 2.1.3 Electricity .....                                    | 17 |
| 2.1.4 ESD .....  | 18 |
| 2.1.5 Laser .....  | 18 |
| 2.2 Installation Site Requirements .....                   | 18 |
| 2.2.1 Ventilation .....                                    | 19 |
| 2.2.2 Temperature and Humidity .....                       | 19 |
| 2.2.3 Cleanness .....                                      | 19 |
| 2.2.4 Interference Resistance .....                        | 20 |
| 2.2.5 Grounding .....                                      | 20 |
| 2.2.6 Lightning Resistance .....                           | 21 |
| 2.2.7 EMI .....  | 22 |
| 2.3 Installation Tools .....                               | 22 |
| 3 Product Installation .....                               | 23 |
| 3.1 Installation Flowchart .....                           | 23 |
| 3.2 Confirmations Before Installation .....                | 23 |
| 3.3 Installing the RG-NBS3100 .....                        | 24 |
| 3.3.1 Mounting the Switch to a Standard 19-inch Rack ..... | 24 |
| 3.3.2 Mounting the Switch on a Table .....                 | 26 |
| 3.4 Grounding the Switch .....                             | 26 |
| 3.5 Connecting External Cables .....                       | 27 |
| 3.6 Bundling Cables .....                                  | 27 |
| 3.7 Checking After Installation .....                      | 28 |

4 System Commissioning.....29

    4.1 Establishing the Configuration Environment .....29

    4.2 Startup.....29

5 Troubleshooting.....31

    5.1 Troubleshooting Flowchart .....31

    5.2 Troubleshooting Common Faults .....31

6 Appendix A Connectors and Connection Media .....33

7 Appendix B Mini-GBIC and SPF Module .....35

8 Appendix C Surge Protection.....39

9 Appendix D Cabling Recommendations .....42

10 Appendix E Site Selection.....46

# 1 Product Overview

## RG-NBS3100 Series Switches


| Model                 | 10/100/1000 Base-T Ethernet Port | 1000Base-X SFP Port | Console Port | Fan Module | Power Module  |
|-----------------------|----------------------------------|---------------------|--------------|------------|---------------|
| RG-NBS3100-24GT4SFP   | 24                               | 4                   | N/A          | N/A        | Single        |
| RG-NBS3100-24GT4SFP-P | 24 (PoE+ support)                | 4                   | N/A          | 2          | Single        |
| RG-NBS3100-8GT2SFP    | 8                                | 2                   | N/A          | N/A        | Power adapter |
| RG-NBS3100-8GT2SFP-P  | 8 (PoE+ support)                 | 2                   | N/A          | N/A        | Single        |

### Note

- The SFP port is downward compatible with 100Base-FX.
- 1000Base-T is downward compatible with 100Base-TX and 10Base-T.

## 1.1 RG-NBS3100-24GT4SFP

### 1.1.1 Technical Specifications

|                |  |
|----------------|--|
| Model          | RG-NBS3100-24GT4SFP  |
| CPU            | Built-in CPU, single-core processor, and 500 MHz   |
| Flash Memory   | 16 MB  |
| SDRAM          | DDRIII 256 MB  |
| Optical Module | <p>The copper cable is not supported. See <i>Appendix B</i>.</p> <hr/> <p> <b>Note</b></p> <p>The supported module type may change at any time. Consult Ruijie Networks for the latest information.</p> <hr/> |
| SFP Port       | 1000Base-X<br>100Base-X  |

|                        |  |
|------------------------|--|
| Power Supply           | AC input<br>Rated voltage range: 100 V to 240 V<br>Maximum voltage range: 90 V to 264 V<br>Frequency: 50/60 Hz<br>Rated current: 0.6 A |
| Input Leakage Current  | ≤ 3.5 mA   |
| EEE                    | Supported  |
| PoE                    | Not supported  |
| Power Consumption      | 21 W   |
| Temperature            | Operating temperature: 0°C to 50°C (32°F to +122°F)<br>Storage temperature: -40°C to +70°C (-40°F to +158°F)                           |
| Humidity               | Operating humidity: 10% to 90% RH<br>Storage humidity: 5% to 95% RH  |
| Number of Fans         | Fanless  |
| Temperature Alarm      | Not supported  |
| Certification          | CE   |
| Dimensions (W x D x H) | 440 mm x 165 mm x 44 mm  |
| Net Weight             | 2.4 kg   |

---

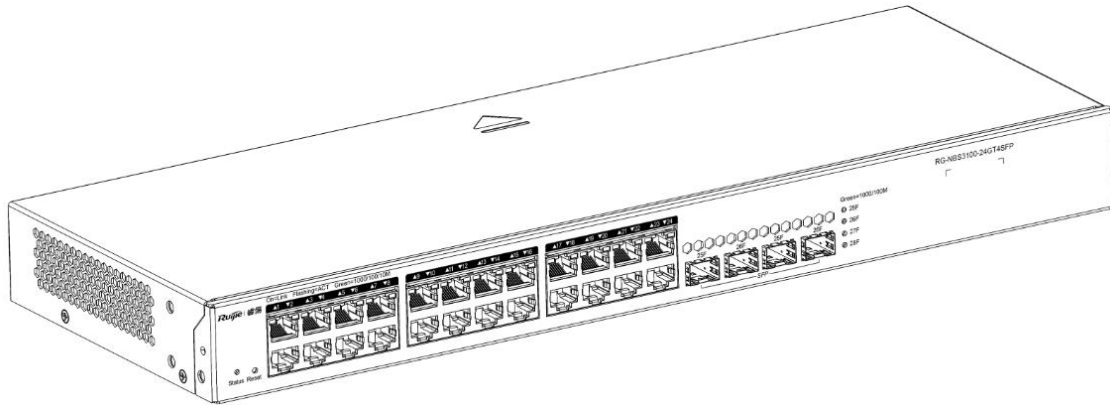
**! Warning**

- Operation of this equipment in a residential environment could cause radio interference.
  - This equipment is not suitable for use in locations where children are likely to be present.
- 

### 1.1.2 Product Appearance

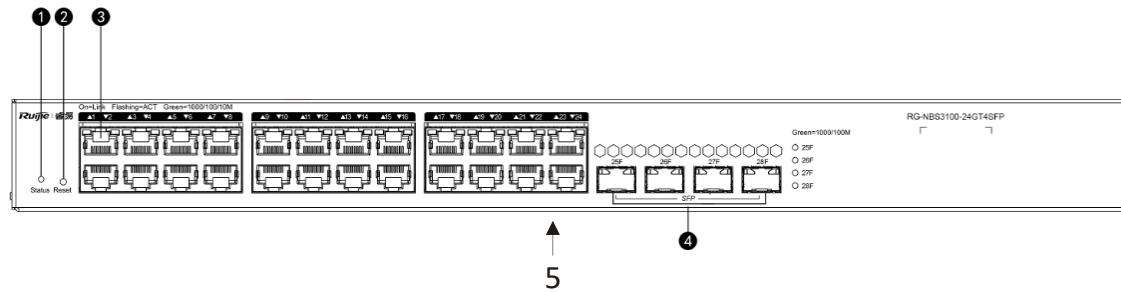
On the front panel, the RG-NBS3100-24GT4SFP Ethernet switch provides twenty-four 10/100/1000Base-T Ethernet ports and four SFP ports. On the back panel, it provides an AC power port.

Figure 1-1 Appearance of the RG-NBS3100-24GT4SFP



Front Panel

Figure 1-2 Front Panel of the RG-NBS3100-24GT4SFP



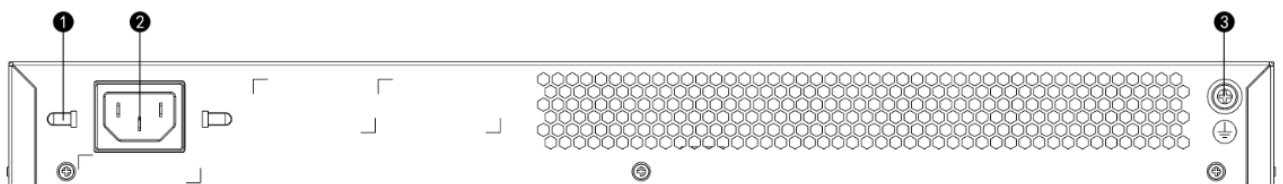
|       |   |   |
|-------|---|---|
| Note: | 1. System status LED<br>2. Reset button | 3. 10/100/1000 Base-T Ethernet port<br>4. 1000Base-X SFP port<br>5. Nameplate on the bottom of the device |
|-------|---|---|

**i** Note

- The switch restarts after the reset button is pressed for less than 2 seconds.
- The switch restores the default factory settings after the reset button is pressed for more than 5 seconds (until the status LED blinks).

Back Panel

Figure 1-3 Back Panel of the RG-NBS3100-24GT4SFP



|       |  |  |
|-------|--|--|
| Note: | 1. Power cord retention clips<br>2. Three-hole AC power receptacle | 3. Protective earthing terminal<br>Nameplate (on the bottom of the device) |
|-------|--|--|

 Note

- This device relies on the separate protective earthing terminal.
- The device installation must be permanently grounded.
- The device must be intended to be used in a location with equipotential bonding (such as a telecommunication center, a dedicated computer room, or a restricted access area).

### 1.1.3 Heat Dissipation

The RG-NBS3100-24GT4SFP adopts natural heat dissipation, thereby ensuring normal operation. You must reserve 10 cm distance space at both sides and the back plane of the cabinet to allow airflow. It is recommended that you clean the device once every three months to avoid dust from blocking vents.


### 1.1.4 LED

| LED  | Panel Identification | State                   | Meaning  |
|--|----------------------|-------------------------|--|
| System status LED                          | Status               | Off                     | The switch is not receiving power.                           |
|  |                      | Blinking green (0.5 Hz) | The switch is running, but is not connected to Ruijie Cloud. |
|  |                      | Blinking green (10 Hz)  | The switch is being upgraded or initialized.                 |
|  |                      | Solid green             | The switch is connected to Ruijie Cloud.                     |
| 10/100/1000Base-T Ethernet port status LED | 1–24                 | Off                     | The port is not connected.                                   |
|  |                      | Solid green             | The port is connected at a rate of 10/100/1000 Mbps.         |
|  |                      | Blinking green          | The port is receiving or transmitting traffic.               |
| SFP port status LED                        | 25–28                | Off                     | The port is not connected.                                   |
|  |                      | Solid green             | The port is connected at a rate of 100/1000 Mbps.            |
|  |                      | Blinking green          | The port is receiving or transmitting traffic.               |

## 1.2 RG-NBS3100-24GT4SFP-P

### 1.2.1 Technical Specifications

|       |                       |
|-------|-----------------------|
| Model | RG-NBS3100-24GT4SFP-P |
|-------|-----------------------|


|                        |   |
|------------------------|---|
| CPU                    | Built-in CPU, single-core processor, and 500 MHz  |
| Flash Memory           | 16 MB   |
| SDRAM                  | DDRIII 256 MB   |
| Optical Module         | <p>The copper cable is not supported. See <i>Appendix B</i>.</p> <hr/> <p> Note</p> <p>The supported module type may change at any time. Consult Ruijie Networks for the latest information.</p> <hr/> |
| SFP Port               | <p>1000Base-X</p> <p>100Base-X</p>  |
| Power Supply           | <p>AC input</p> <p>Rated voltage range: 100 V to 240 V</p> <p>Maximum voltage range: 90 V to 264 V</p> <p>Frequency: 50/60 Hz</p> <p>Rated current: 6 A</p>   |
| Input Leakage Current  | ≤ 3.5 mA  |
| EEE                    | Supported   |
| PoE                    | <p>PoE/PoE+ support</p> <p>Ports 1 to 24 support PoE/PoE+ with the maximum power output of 30 W per port.</p> <p>The overall maximum output power of PoE/PoE+ is 370 W.</p>   |
| PoE Power Pins         | Mode A (1/2+, 3/6-)   |
| Power Consumption      | <p>21 W with no PoE load</p> <p>443 W with PoE full load</p>  |
| Temperature            | <p>Operating temperature: 0°C to 50°C (32°F to +122°F)</p> <p>Storage temperature: -40°C to +70°C (-40°F to +158°F)</p>   |
| Humidity               | <p>Operating humidity: 10% to 90% RH</p> <p>Storage humidity: 5% to 95% RH</p>  |
| Number of Fans         | Two fans  |
| Temperature Alarm      | Not supported   |
| Certification          | CE  |
| Dimensions (W x D x H) | 440 mm x 293 mm x 44 mm   |

|            |        |
|------------|--------|
| Net Weight | 4.5 kg |
|------------|--------|

**Warning**

- Operation of this equipment in a residential environment could cause radio interference.
- This equipment is not suitable for use in locations where children are likely to be present.

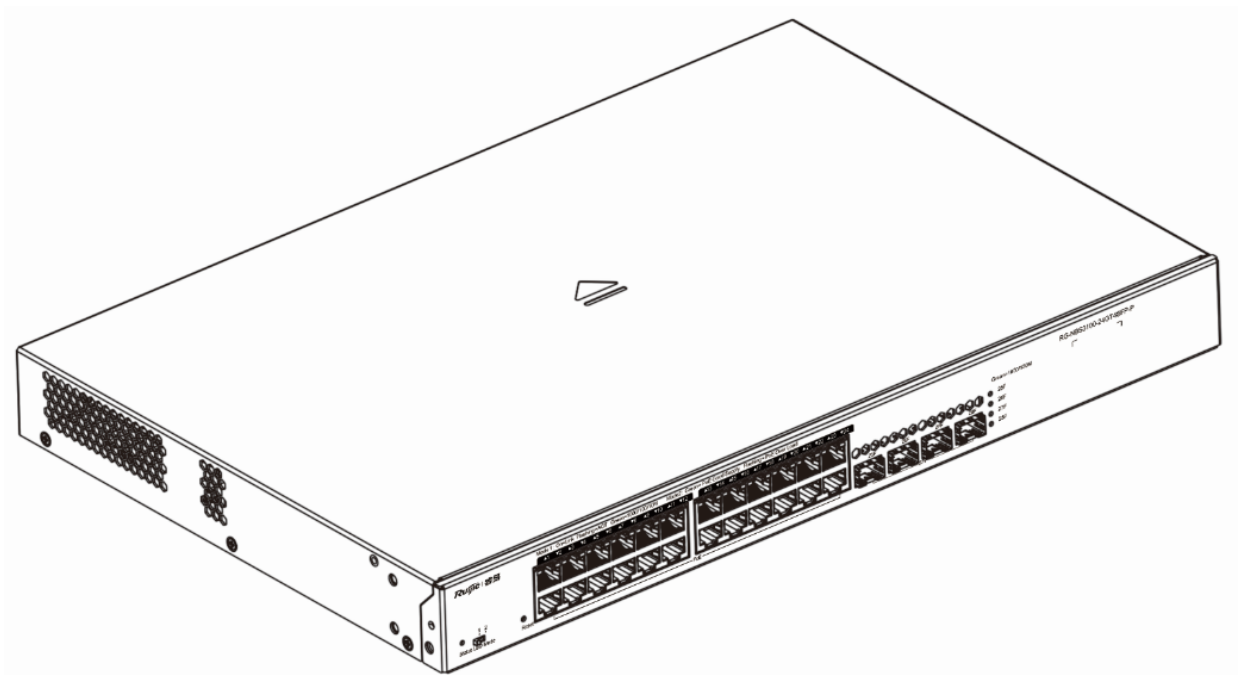
**Note**

The high temperature label  indicates that the device must be installed in the restricted area when the ambient temperature exceeds 50°C.

### 1.2.2 Product Appearance

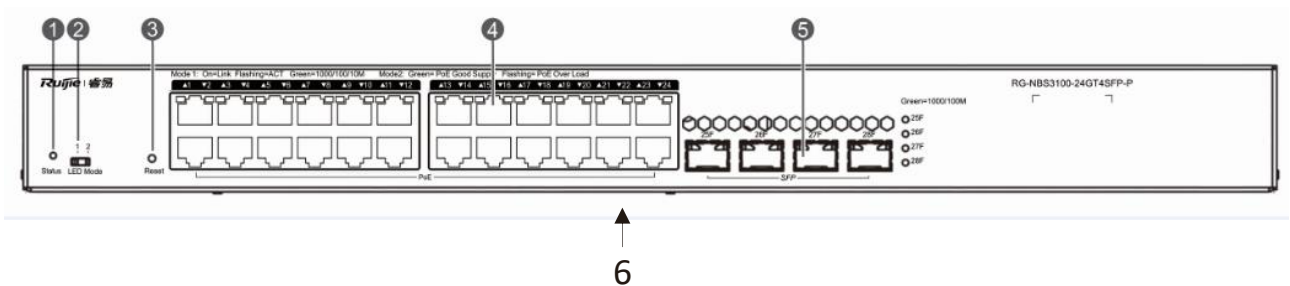
On the front panel, the RG-NBS3100-24GT4SFP-P Ethernet switch provides twenty-four 10/100/1000Base-T Ethernet ports and four SFP ports. On the back panel, it provides an AC power port.

Figure 1-4 Appearance of the RG-NBS3100-24GT4SFP-P



Front Panel

Figure 1-5 Front Panel of the RG-NBS3100-24GT4SFP-P



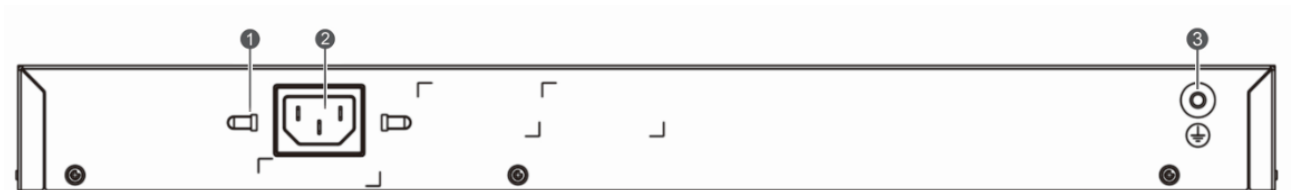
|       |                                |  |
|-------|--------------------------------|--|
| Note: | 1. System status LED           | 4. 10/100/1000 Base-T Ethernet port      |
|       | 2. PoE mode switch-over button | 5. 1000Base-X SFP port                   |
|       | 3. Reset button                | 6. Nameplate on the bottom of the device |

**i** Note

- The switch restarts after the reset button is pressed for less than 2 seconds.
- The switch restores the default factory settings after the reset button is pressed for more than 5 seconds (until the status LED blinks).
- When the button is turned to the left position (Mode 1), the LED indicates the switching status of the port. When the LED is solid green, the link is Up. When the LED blinks green, data is being transmitted or received.
- When the button is turned to the right position (Mode 2), the LED indicates the PoE status of ports. When the LED is solid green, the PoE-supported ports are supplying power. When the LED blinks green, the power of the ports is overloaded.

## Back Panel

**Figure 1-6 Back Panel of the RG-NBS3100-24GT4SFP-P**



|       |                                   |                                 |
|-------|-----------------------------------|---------------------------------|
| Note: | 1. Power cord retention clips     | 3. Protective earthing terminal |
|       | 2. Three-hole AC power receptacle |                                 |

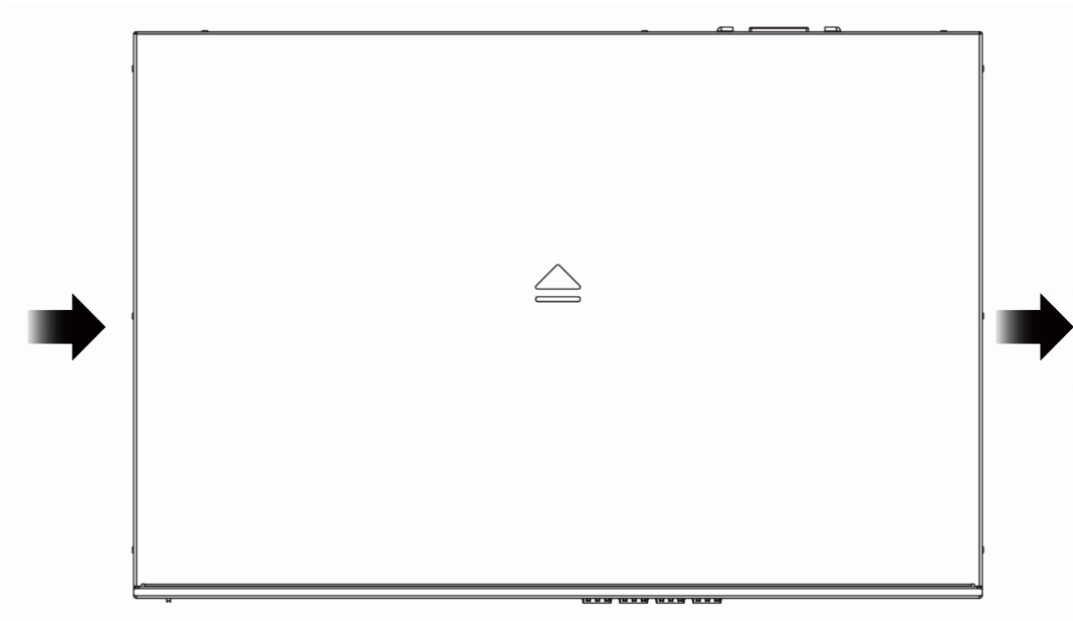
**i** Note

- This device relies on the separate protective earthing terminal.
- The device installation must be permanently grounded.
- The device must be intended to be used in a location with equipotential bonding (such as a telecommunication center, a dedicated computer room, or a restricted access area).

### 1.2.3 Heat Dissipation

The RG-NBS3100-24GT4SFP-P adopts fans for heat dissipation, thereby ensuring normal operation. You must reserve 10 cm distance space at both sides and the back plane of the cabinet to allow airflow. It is recommended that you clean the device once every three months to avoid dust from blocking vents.

Figure 1-7 Flow Scheme of Heat Dissipation




1.2.4 LED

| LED  | Panel Identification | State                   | Meaning  |
|--|----------------------|-------------------------|--|
| System status LED                          | Status               | Off                     | The switch is not receiving power.   |
|  |                      | Blinking green (0.5 Hz) | The switch is running, but the alarm of insufficient PoE power prompts.      |
|  |                      | Blinking green (10 Hz)  | The switch is being upgraded or initialized.                                 |
|  |                      | Solid green             | The switch is connected to Ruijie Cloud.                                     |
| 10/100/1000Base-T Ethernet port status LED | 1-24                 | Off                     | The port is not connected.   |
|  |                      | Solid green             | The port is connected at a rate of 10/100/1000 Mbps.                         |
|  |                      | Blinking green          | The port is receiving or transmitting traffic at a rate of 10/100/1000 Mbps. |
| RJ45 port PoE status LED                   | 1-24                 | Off                     | PoE is not enabled.  |
|  |                      | Solid green             | PoE is enabled. The port is operational.                                     |
|  |                      | Blinking green          | The port has a PoE fault of overload.  |
| SFP port status LED                        | 25F-28F              | Off                     | The port is not connected.   |
|  |                      | Solid green             | The port is connected.   |
|  |                      | Blinking green          | The port is receiving or transmitting traffic.                               |

## 1.3 RG-NBS3100-8GT2SFP

### 1.3.1 Technical Specifications

|                          |   |
|--------------------------|---|
| Model                    | RG-NBS3100-8GT2SFP  |
| CPU                      | Built-in CPU, single-core processor, 500 MHz  |
| Flash Memory             | 16 MB   |
| SDRAM                    | DDRIII 256 MB   |
| Optical Module           | <p>The copper cable is not supported. See <i>Appendix B</i>.</p> <hr/> <p> Note</p> <p>The supported module type may change at any time. Consult Ruijie Networks for the latest information.</p> <hr/> |
| SFP Port                 | 1000Base-X<br>100Base-FX  |
| Power Supply             | <p>Adapter input</p> <p>Rated voltage range: 100 V to 240 V</p> <p>Maximum voltage range: 90 V to 264 V</p> <p>Frequency: 50/60 Hz</p> <p>Rated current: 1 A</p> <p>Adapter output</p> <p>Rated voltage range: 12 V DC</p> <p>Rated current range: 1 A</p>                              |
| EEE                      | Supported   |
| PoE                      | Not supported   |
| Power Consumption        | 8W  |
| Temperature              | <p>Operating temperature: 0°C to 50°C (32°F to +122°F)</p> <p>Storage temperature: -40°C to +70°C (-40°F to +158°F)</p>   |
| Humidity                 | <p>Operating humidity: 10% to 90% RH</p> <p>Storage humidity: 5% to 95% RH</p>  |
| Number of Fans           | Fanless   |
| Temperature Alarm        | Not supported   |
| Accessing Optical Module | Not supported   |

|                        |                           |
|------------------------|---------------------------|
| Information            |                           |
| Certification          | CE                        |
| Earth Leakage Current  | ≤ 0.25 mA                 |
| Dimensions (W x D x H) | 260 mm x 120 mm x 43.6 mm |
| Net Weight             | 1.2 kg                    |

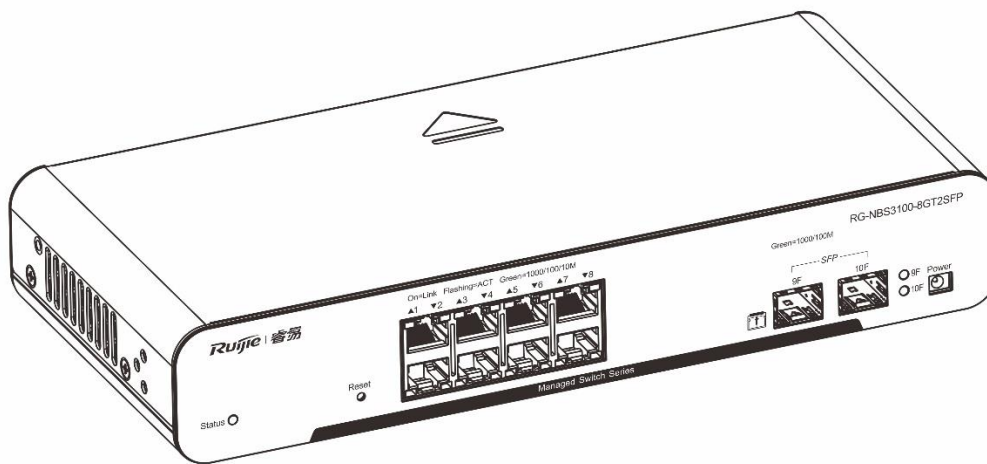
**Warning**

- Operation of this equipment in a residential environment could cause radio interference.
- This equipment is not suitable for use in locations where children are likely to be present.

### 1.3.2 Product Appearance

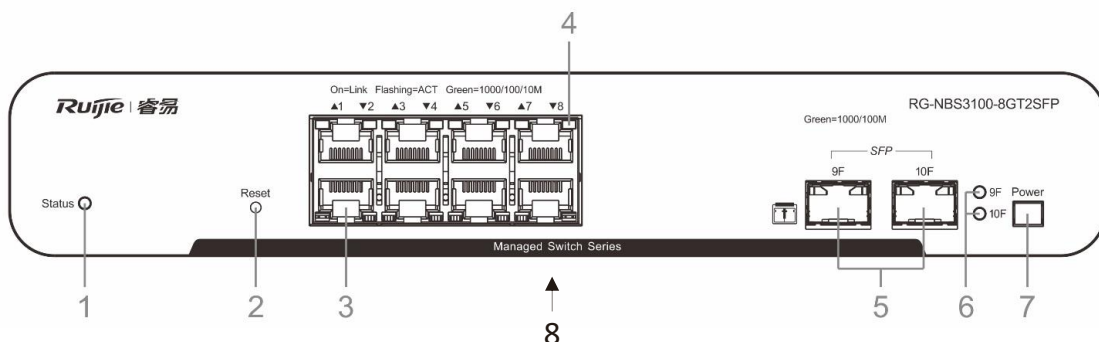
On the front panel, the RG-NBS3100-8GT2SFP Ethernet switch provides eight 10/100/1000Base-T Ethernet ports, two SFP ports, one reset button, and one DC power port.

Figure 1-8 Appearance of the RG-NBS3100-8GT2SFP



Front Panel

Figure 1-9 Front Panel of the RG-NBS3100-8GT2SFP



|       |   |   |
|-------|---|---|
| Note: | 1. System status LED<br>2. Reset button<br>3. 10/100/1000 Base-T Ethernet port<br>4. Copper port status LED | 5. 1000 Base-X SFP port<br>6. SFP port status LED<br>7. DC power port<br>8. Nameplate on the bottom of the device |
|-------|---|---|

**Note**

- The switch restarts after the reset button is pressed for less than 2 seconds.
- The switch restores the default factory settings after the reset button is pressed for more than 5 seconds (until the status LED blinks).

**Back Panel**

**Figure 1-10 Back Panel of the RG-NBS3100-8GT2SFP**



|       |                                 |                             |
|-------|---------------------------------|-----------------------------|
| Note: | 1. Protective earthing terminal | 2. Hole for anti-theft lock |
|-------|---------------------------------|-----------------------------|

**Note**

- This device relies on the separate protective earthing terminal.
- The device installation must be permanently grounded.
- The device must be intended to be used in a location with equipotential bonding (such as a telecommunication center, a dedicated computer room, or a restricted access area).

### 1.3.3 Heat Dissipation

The RG-NBS3100-8GT2SFP adopts natural heat dissipation, thereby ensuring normal operation. You must reserve 10 cm distance space at both sides and the back plane of the cabinet to allow airflow. It is recommended that you clean the device once every three months to avoid dust from blocking vents.


### 1.3.4 LED

| LED               | Panel Identification | State                   | Meaning  |
|-------------------|----------------------|-------------------------|--|
| System status LED | Status               | Off                     | The switch is not receiving power.                           |
|                   |                      | Blinking green (0.5 Hz) | The switch is running, but is not connected to Ruijie Cloud. |
|                   |                      | Blinking green (10 Hz)  | The switch is being upgraded or initialized.                 |
|                   |                      | Solid green             | The switch is connected to Ruijie Cloud.                     |

| LED  | Panel Identification | State          | Meaning  |
|--|----------------------|----------------|--|
| 10/100/1000Base-T Ethernet port status LED | 1–8                  | Off            | The port is not connected.   |
|  |                      | Solid green    | The port is connected at a rate of 10/100/1000 Mbps.                         |
|  |                      | Blinking green | The port is receiving or transmitting traffic at a rate of 10/100/1000 Mbps. |
| SFP port status LED                        | 9F–10F               | Off            | The port is not connected.   |
|  |                      | Solid green    | The port is connected at a rate of 100/1000 Mbps.                            |
|  |                      | Blinking green | The port is receiving or transmitting traffic at a rate of 100/1000 Mbps.    |

## 1.4 RG-NBS3100-8GT2SFP-P

### 1.4.1 Technical Specifications

|                |   |
|----------------|---|
| Model          | RG-NBS3100-8GT2SFP-P  |
| CPU            | Built-in CPU, single-core processor, 500 MHz  |
| Flash Memory   | 16 MB   |
| SDRAM          | DDRIII 256 MB   |
| Optical Module | <p>See <i>Appendix B</i>.</p> <p>The copper cable is not supported.</p> <hr/> <p> <b>Note</b></p> <p>The supported module type may change at any time. Consult Ruijie Networks for the latest information.</p> <hr/> |
| SFP Port       | <p>1000Base-X</p> <p>100Base-FX</p>   |
| Power Supply   | <p>AC input</p> <p>Rated voltage range: 100 V to 240 V</p> <p>Maximum voltage range: 90 V to 264 V</p> <p>Frequency: 50/60 Hz</p> <p>Rated current: 2A</p> <p>Power cord: 10A</p>   |
| EEE            | Supported   |
| PoE            | <p>PoE/PoE+ support</p> <p>Ports 1 to 8 support PoE/PoE+ with the maximum power output of 30 W per port. Port 9</p>   |


|                                      |   |
|--------------------------------------|---|
|                                      | <p>does not support PoE.</p> <p>The overall maximum output power of PoE/PoE+ is 125 W.</p>                              |
| PoE Power Pins                       | Mode A (1/2+, 3/6-)   |
| Power Consumption                    | <p>11W with no PoE load;</p> <p>145W with PoE full load</p>   |
| Temperature                          | <p>Operating temperature: 0°C to 50°C (32°F to +122°F)</p> <p>Storage temperature: -40°C to +70°C (-40°F to +158°F)</p> |
| Humidity                             | <p>Operating humidity: 10% to 90% RH</p> <p>Storage humidity: 5% to 95% RH</p>  |
| Number of Fans                       | Fanless   |
| Temperature Alarm                    | Not supported   |
| Accessing Optical Module Information | Not supported   |
| Certification                        | CE  |
| Input Leakage Current                | $\leq 1.5$ mA   |
| Dimensions (W x D x H)               | 300 mm x 220 mm x 43.6 mm   |
| Net Weight                           | 2 kg  |

---

**!** **Warning**

- Operation of this equipment in a residential environment could cause radio interference.
  - This equipment is not suitable for use in locations where children are likely to be present.
- 

**i** **Note**

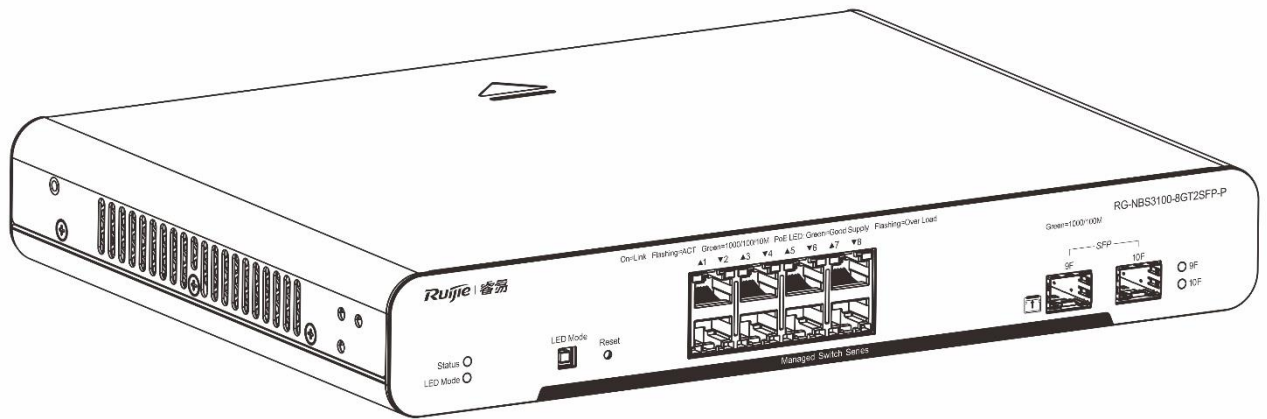
The high temperature label  indicates that the device must be installed in the restricted area when the ambient temperature exceeds 50°C.

---

## 1.4.2 Product Appearance

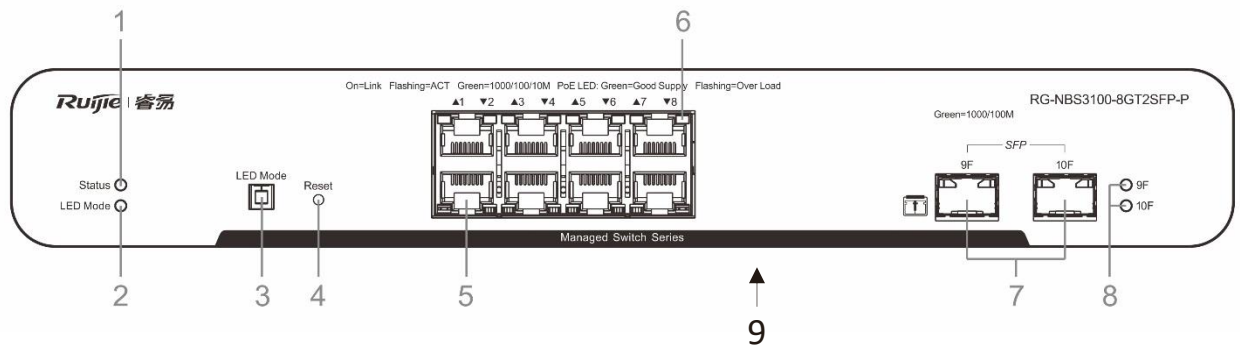
On the front panel, the RG-NBS3100-8GT2SFP-P Ethernet switch provides 8 10/100/1000Base-T Ethernet ports, 2 SFP ports, 1 reset button, and 1 PoE mode switch-over button. On the back panel, it provides an AC power port.

Figure 1-11 Appearance of the RG-NBS3100-8GT2SFP-P



Front Panel

Figure 1-12 Front Panel of the RG-NBS3100-8GT2SP-P



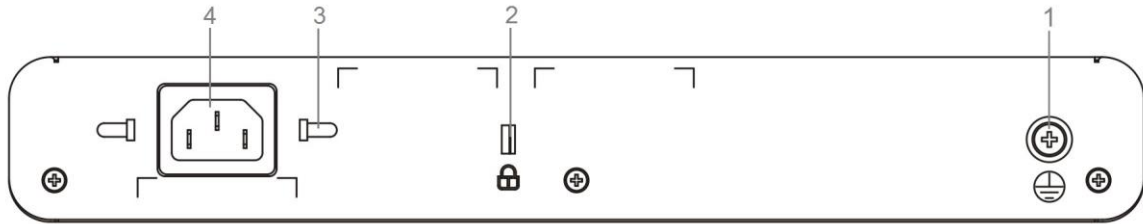
|              |   |  |
|--------------|---|--|
| <p>Note:</p> | <ol style="list-style-type: none"> <li>1. System status LED</li> <li>2. Port mode LED</li> <li>3. PoE mode switch-over button</li> <li>4. Reset button</li> </ol> | <ol style="list-style-type: none"> <li>5. 10/100/1000 Base-T Ethernet port</li> <li>6. Copper port status LED</li> <li>7. 1000Base-X SFP port</li> <li>8. SFP port status LED</li> <li>9. Nameplate on the bottom of the device</li> </ol> |
|--------------|---|--|

**Note**

- The switch restarts after the reset button is pressed for less than 2 seconds.
- The switch restores the default factory settings after the reset button is pressed for more than 5 seconds (until the status LED blinks).
- When the PoE mode switch-over button is pressed, the port mode LED turns on, indicating the PoE mode of the port. When the PoE mode switch-over button is released, the port mode LED turns off, indicating the switching mode of the port.

Back Panel

Figure 1-13 Back Panel of the RG-NBS3100-8GT2SFP-P



|       |  |  |
|-------|--|--|
| Note: | 1. Protective earthing terminal<br>2. Hole for anti-theft lock | 3. Power cord retention clips<br>4. Three-hole AC power receptacle |
|-------|--|--|

#### **Note**

- This device relies on the separate protective earthing terminal.
- The device installation must be permanently grounded.
- The device must be intended to be used in a location with equipotential bonding (such as a telecommunication center, a dedicated computer room, or a restricted access area).

### 1.4.3 Heat Dissipation

RG-NBS3100-8GT2SFP-P adopts natural heat dissipation, thereby ensuring normal operation. You must reserve 10 cm distance space at both sides and the back plane of the cabinet to allow airflow. It is recommended that you clean the device once every three months to avoid dust from blocking vents.

### 1.4.4 LED

| LED  | Panel Identification | State                   | Meaning  |
|--|----------------------|-------------------------|--|
| System status LED                          | Status               | Off                     | The switch is not receiving power.   |
|  |                      | Blinking green (0.5 Hz) | The switch is running, but is not connected to Ruijie Cloud.                 |
|  |                      | Blinking green (10 Hz)  | The switch is being upgraded or initialized.                                 |
|  |                      | Solid green             | The switch is connected to Ruijie Cloud.                                     |
| Port mode LED                              | LED Mode             | Off                     | Switching mode.  |
|  |                      | Solid green             | PoE mode.  |
| 10/100/1000Base-T Ethernet port status LED | 1-8                  | Off                     | The port is not connected.   |
|  |                      | Solid green             | The port is connected at a rate of 10/100/1000 Mbps.                         |
|  |                      | Blinking green          | The port is receiving or transmitting traffic at a rate of 10/100/1000 Mbps. |
| RJ45 port PoE status LED                   | 1-8                  | Off                     | PoE is not enabled.  |
|  |                      | Solid green             | PoE is enabled. The port is operational.                                     |

| LED                    | Panel Identification | State          | Meaning   |
|------------------------|----------------------|----------------|---|
|                        |                      | Blinking green | The port has a PoE fault of overload.                                     |
| SFP port status<br>LED | 9F-10F               | Off            | The port is not connected.  |
|                        |                      | Solid green    | The port is connected at a rate of 100/1000 Mbps.                         |
|                        |                      | Blinking green | The port is receiving or transmitting traffic at a rate of 100/1000 Mbps. |

# 2 Preparation before Installation

## 2.1 Safety Suggestions

To avoid personal injury and device damage, carefully read the safety suggestions before you install the RG-NBS3100 series.

---

 **Caution**

The following safety suggestions do not cover all possible dangers.

---

### 2.1.1 Installation

- Keep the chassis clean and free from any dust.
- Do not place the equipment in a walking area.
- Do not wear loose clothes or accessories that may be hooked or caught by the device during installation and maintenance.
- Turn off all power supplies and remove power sockets and cables before installing or uninstalling the device.


### 2.1.2 Movement

- Do not frequently move the device.
- When moving the device, note the balance and avoid hurting legs and feet or straining the back.
- Before moving the device, turn off all power supplies and dismantle all power modules.

### 2.1.3 Electricity

- Observe local regulations and specifications when performing electric operations. Relevant operators must be qualified.
- Before installing the device, carefully check any potential danger in the surroundings, such as ungrounded power supply, and damp or wet ground or floor.
- Before installing the device, find out the location of the emergency power supply switch in the room. First cut off the power supply in the case of an accident.
- Try to avoid maintaining the switch that is powered on alone.
- Be sure to make a careful check before you shut down the power supply.
- Do not place the device in a damp location. Do not let any liquid enter the chassis.

---

 **Caution**

- Any nonstandard and inaccurate electric operation may cause an accident such as fire or electrical shock, thus causing severe even fatal damages to human bodies and the device.
- Direct or indirect touch through a wet object on high-voltage and mains supply may bring a fatal danger.
- If a power supply system is equipped with a leakage protector (leakage current switch or breaker), the rated leakage action current of each leakage protector is twice greater than the maximum leakage current of all the power supplies in the system. For example, if a system is equipped with twenty identical power

supplies, the leakage current of each power supply is equal to or less than 1.5 mA, and the total leakage current of the system is 30 mA. A leakage protector with 30 mA rated action current supports less than ten power supplies (that is, action current of the leakage protector/2/maximum leakage current of each power supply =  $30/2/1.5 = 10$ ). In other words, the leakage protector with 30 mA rated action current supports no more than ten power supplies. In this case, the twenty power supplies in the system require at least two leakage protectors with 30 mA rated action current and each leakage protector supports ten power supplies. If power supplies in a system differ in models, the rated leakage action current of each leakage protector divided by two is greater than the sum of maximum leakage current of all the power supplies. The rated leakage non-action current of a leakage protector must be 50% of the leakage action current. The leakage protector with 30 mA rated leakage action current is used as an example. The rated leakage non-action current must be 15 mA. When the leakage current falls below 15 mA, the protector should not act. Otherwise, misoperation may easily occur due to high sensitivity and thus the leakage protector trips, devices are powered off, and services are interrupted.

- To guarantee personal safety, the rated leakage action current of each leakage protector in the system must be equal to or less than 30 mA (human body safety current is 30 mA). When twice of the total leakage current of the system is greater than 30 mA, the system must be equipped with two or more leakage protectors.
  - For details of the leakage current value of each power supply model, see Chapter 1 Product Overview.
- 

### 2.1.4 ESD

To prevent Electronic Static Discharge (ESD), pay attention to the following points:

- Proper grounding of grounding screws on the back panel of the device, and three-wire single-phase socket with protective earth wire (PE) used as the AC power socket.
- Indoor dust prevention
- Proper humidity conditions

### 2.1.5 Laser

The RG-NBS3100 series switches support varying models of optical modules (Class I laser products) sold on the market. Improper use of optical modules may cause damage. Therefore, pay attention to the following points:

- When a fiber transceiver works, ensure that the port has been connected to an optical fiber or is covered with a dust cap, to keep out dust and avoid burning your eyes.
- When the optical module is working, do not pull out the fiber cable or look directly into the transceiver. The transceiver emits laser light that may hurt your eyes.

---

#### **Caution**

Do not stare into any optical port under any circumstances because this may cause permanent damage to your eyes.

---

## 2.2 Installation Site Requirements

The installation site must meet the following requirement to ensure normal working and a prolonged durable life of the switch.

## 2.2.1 Ventilation

For the RG-NBS3100 series, a sufficient space (at least 10 cm distance from both sides and the back plane of the cabinet) should be reserved at the ventilation openings to ensure normal ventilation. After various cables have been connected, they should be arranged into bundles or placed on the cabling rack to avoid airflow blocking. It is recommended that you clean the switch at regular intervals (like once every three months). In particular, avoid dust from blocking the screen mesh on the back of the cabinet.

## 2.2.2 Temperature and Humidity

To ensure the normal operation and prolong the service life of the RG-NBS3100 series switch, keep proper temperature and humidity in the equipment room.

If the equipment room has temperature and humidity that do not meet the requirements for a long time, the equipment may be damaged.

- In an environment with a high humidity, insulating materials may have bad insulation or even leaking electricity. Sometimes the materials may suffer from mechanical performance change and metallic parts may get rusted.
- In an environment with a low humidity, insulating strips may dry and shrink. Static electricity may occur easily and endanger circuits on the device.
- In an environment with a high temperature, the router is subject to more serious harm. Its performance may degrade significantly and various hardware faults may occur.

The ambient temperature and humidity of the RG-NBS3100 series switch must meet the requirements listed in Table 2-1.

Table 2-1 Temperature and Humidity Requirements of the RG-NBS3100 Series Switch

| Temperature                 | Relative Humidity |
|-----------------------------|-------------------|
| 0°C to 50°C (32°F to 122°F) | 10% to 90%        |

The requirements for the sampling site of the temperature and humidity in the operating environment of the device are as follows:

### Caution

- There is no protective plate at the front or back of the rack.
- The vertical height is 1.5 m above the floor.
- The distance from the front panel of the device is 0.4 m.

## 2.2.3 Cleanness

Dust poses a severe threat to the running of the device. The indoor dust falling on the device may be absorbed by the static electricity, causing bad contact of the metallic joint. Such electrostatic absorption may occur more easily when the relative humidity is low. This affects the device lifecycle and causes communication faults. Table 2-2 lists the requirements for the dust content and granularity in the equipment room.

Table 2-2 Requirements for the Dust Content and Granularity in the Equipment Room

| Dust | Unit | Density |
|------|------|---------|
|------|------|---------|

|                                 |                            |                        |
|---------------------------------|----------------------------|------------------------|
| Diameter $\geq 0.5 \mu\text{m}$ | Particles/<br>$\text{m}^3$ | $\leq 3.5 \times 10^6$ |
| Diameter $\geq 5 \mu\text{m}$   | Particles/<br>$\text{m}^3$ | $\leq 3 \times 10^4$   |

Apart from dust, the salt, acid, and sulfide in the air in the equipment room must also meet strict requirements. This is because such poisonous substances may accelerate the corrosion of the metal and the aging of some parts. The equipment room should be protected from the intrusion of harmful gases such as sulfur dioxide, sulfured hydrogen, nitrogen dioxide, and chlorine. Table 2-3 lists the requirements.

Table 2-3 Requirements for Harmful Gases in the Equipment Room

| Gas              | Average (mg/m <sup>3</sup> ) | Maximum (mg/m <sup>3</sup> ) |
|------------------|------------------------------|------------------------------|
| SO <sub>2</sub>  | 0.3                          | 1.0                          |
| H <sub>2</sub> S | 0.1                          | 0.5                          |
| NO <sub>2</sub>  | 0.5                          | 1.0                          |
| Cl <sub>2</sub>  | 0.1                          | 0.3                          |

 **Note**

The average and maximum values are measured for a week. The switch cannot be placed in the environment with the maximum density for over 30 minutes every day.

## 2.2.4 Interference Resistance

The switch is vulnerable to external interface caused by capacity coupling, inductance coupling, electromagnetic wave radiation, common impedance (including grounding system) coupling, and conducting wires (including power cords, signal and output wires). Therefore, note the following points:

- The AC power supplying system is the TN system. The single-phase three-wire socket with protecting grounding must be used as the socket for the power supply to enable the device's upper filter circuit to effectively filter the power interface.
- The switch should be far from high-power radio transmitting stations, radar stations and high-frequency and large-current devices.
- Electromagnetic shielding methods should be applied when necessary, such as using the shielded cable as the interface cable.
- Cables must be connected to interfaces inside the room to prevent damage to the device's signal ports caused by over-voltage and over-current generated by thunder and lightning.

## 2.2.5 Grounding

A good grounding system is the basis for stable and reliable operation of the device, preventing lightning strokes and resisting interference. Carefully check the grounding conditions at the installation site according to the grounding requirements, and perform grounding operations properly as required.

**⚠ Caution**

Effective grounding of the switch guarantees surge protection and interference resistance. Therefore, connect the grounding line of the switch properly.

**Safety Grounding**

The device using AC power supply must be grounded by using the yellow/green safety grounding cable. Otherwise, when the insulating resistance decreases the power supply and the enclosure in the equipment, electric shock may occur.

**⚠ Caution**

- The building must provide the protective grounding connection to ensure that the device is connected to the protection location.
- The installation and maintenance personnel must check whether the A.C. socket is well connected to the protection location of the building. If not, use a protective grounding wire to connect the grounding end of the A.C. socket to the building's protection location.
- The power supply socket must be installed in a place that is near to the device and where users can operate the device easily.
- Before device installation, ensure that the ground is connected at first and disconnected finally.
- The sectional area of the protective grounding wire should be at least 0.75 mm<sup>2</sup> (18 AWG).
- Use the 3-core power supply line. The sectional area of each pin should be at least 0.75 mm<sup>2</sup> or 18 AWG.

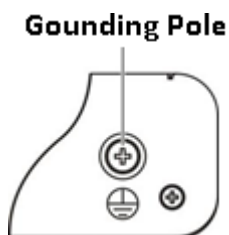
**Lightning Grounding**

The surge protection system of a facility is an independent system that consists of the lightning rod, down conductor, and connector to the grounding system, which usually shares the power reference ground and ground cable. The lightning discharge ground is targeted for the facility.

**EMC Grounding**

The grounding required for EMC design includes the shielding ground, filter ground, noise and interference suppression, and level reference. All the above constitute the comprehensive grounding requirements. The resistance of earth wires should be less than 1 Ω. The RG-NBS3100 series switch back plane is reserved with one grounding pole, as shown in Figure 2-1.

**Figure 2-1 Grounding of the RG-NBS3100**

**2.2.6 Lightning Resistance**

When the AC power cable is imported outdoors and directly connected to the power port of the RG-NBS3100 series switch, use the lightning line bank to prevent the switch from being hit by lightning shocks. In this case, connect the mains supply AC cable to the lightning line bank, and connect the switch to the lightning line bank. This helps prevent the current of high-voltage lightning from passing the switch directly through the mains supply cable to a certain extent.

---

**Note**

The lightning line banks are not provided and should be purchased by customers as required.

---

### 2.2.7 EMI

Electro-Magnetic Interference (EMI), from either outside or inside the device or application system, affects the system in the conductive ways such as capacitive coupling, inductive coupling, and electromagnetic radiation.

There are two types of electromagnetic interference: radiated interference and conducted interference, depending on the type of the transmission path.

When the energy, often RF energy, from a component arrives at a sensitive component through the space, the energy is known as radiated interference. The interference source can be either a part of the interfered system or a completely electrically isolated unit. Conducted interference results from an electromagnetic wire or signal cable connection between the source and the sensitive component, along which cable the interference conducts from one unit to another. Conducted interference often affects the power supply of the device, but can be controlled by a filter. Radiated interference may affect any signal path in the device and is difficult to shield.

- For the TN AC power supply system, the single-phase three-core power socket with protective earthing conductors (PE) should be adopted to effectively filter out interference from the power grid through filtering circuits.
- Do not use the grounding device for an electrical device or anti-lightning grounding device. In addition, the grounding device of the device must be deployed far away from the grounding device of the electrical device and anti-lightning grounding device.
- Keep the device away from the high-power radio transmitter, radar transmitting station, and high-frequency large-current device.
- Take measures to shield static electricity.
- Lay interface cables inside the equipment room. Outdoor cabling is prohibited, avoiding damages to device signal interfaces caused by over-voltage or over-current of lightning.

## 2.3 Installation Tools

Table 2-4 List of Installation Tools

|               |  |
|---------------|--|
| Common Tools  | Phillips screwdriver, flathead screwdriver, related electric cables and optical cables, bolts, diagonal pliers, and straps |
| Special Tools | Anti-static tools  |
| Meters        | Multimeter   |

---

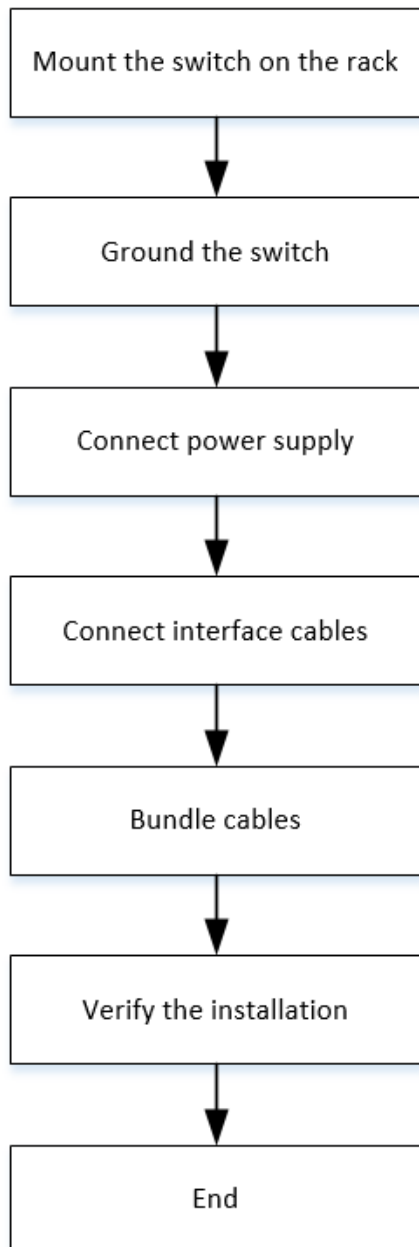
**Note**

The tool kit is customer-supplied.

---

# 3 Product Installation

## 3.1 Installation Flowchart



## 3.2 Confirmations Before Installation

Before installation, confirm the following points:

- Check whether ventilation requirements are met for the switch.
- Check whether the requirements of temperature and humidity are met for the switch.

- Check whether power cables are already laid out and whether the requirements of electrical current are met.
- Check whether related network adaption lines are already laid out.

### 3.3 Installing the RG-NBS3100

#### Precautions

During installation, note the following points:

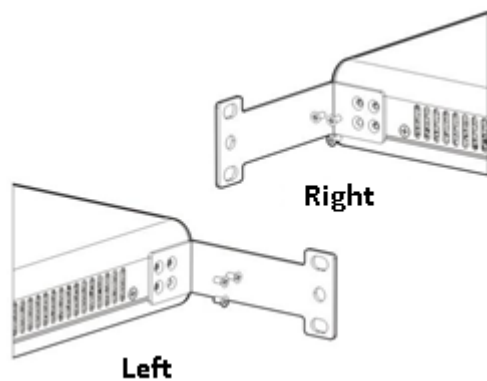
- Connect the power cables of different colors to the corresponding grounding posts.
- Ensure that the interface of the power supply cable is properly connected to the power interface of the device. The power cables must be protected using power cable retention clips after they are connected to the device.
- Do not place any articles on the RG-NBS3100 series switch.
- Reserve a spacing of at least 10 cm around the chassis for good ventilation. Do not stack the devices.
- The switch should be located at places free from the large power radio launch pad, radar launch pad, and high-frequency large-current devices. If necessary, use electromagnetic shielding. For example, use interface cables to shield cables.
- 100-meter network cables should be laid inside the equipment room and outdoor cabling of such cables is prohibited. If outdoor cabling is necessary, take relevant measures for surge protection.

#### 3.3.1 Mounting the Switch to a Standard 19-inch Rack

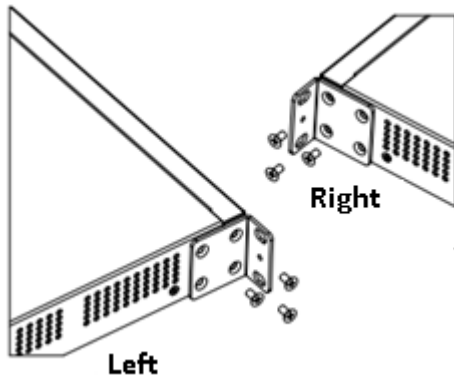
The RG-NBS3100 series switches follow the EIA standard dimensions and can be installed in the 19-inch rack.

Step 1: Attach the mounting brackets to the switch with the supplied screws, as shown in Figure 3-1 and Figure 3-2.

**Figure 3-1 Attaching the Mounting Bracket to the 8-Port Switch**

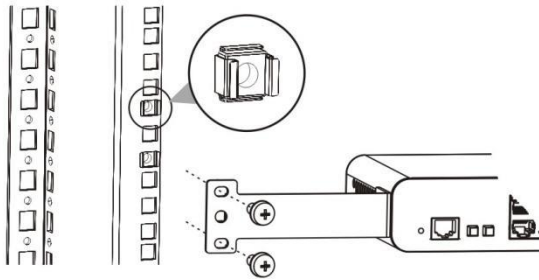


**Figure 3-2 Attaching the Mounting Bracket to the 24-Port Switch**

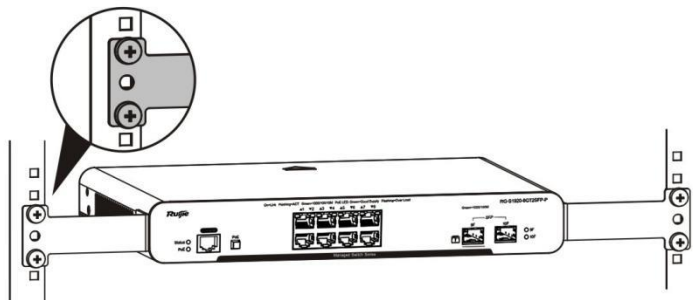


Step 2: Use the supplied M6 screws and cage nuts to securely attach the mounting brackets to the rack, as shown in Figure 3-3, Figure 3-4, Figure 3-5, and Figure 3-6.

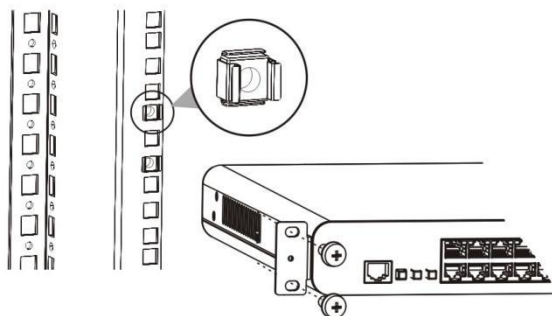
**Figure 3-3 Attaching the Brackets to the Rack (8-Port Switch)**



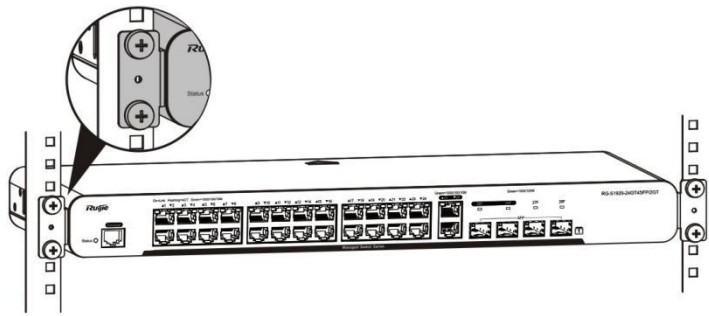
**Figure 3-4 Attaching the Brackets to the Rack (8-Port Switch)**



**Figure 3-5 Attaching the Brackets to the Rack (24-Port Switch)**



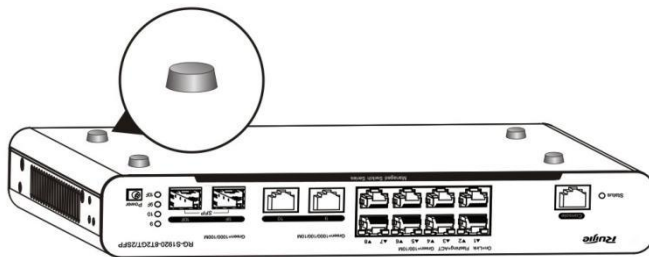
**Figure 3-6 Attaching the Brackets to the Rack (24-Port Switch)**



### 3.3.2 Mounting the Switch on a Table

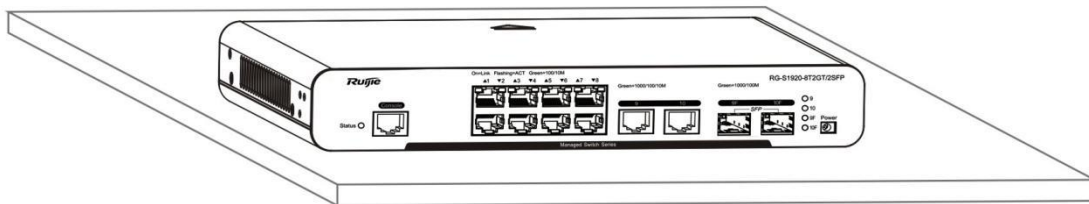
Attach the four rubber pads to the recessed areas on the bottom of the switch, as shown in Figure 3-7 and Figure 3-8.

**Figure 3-7 Attaching the Rubber Feet to the Recessed Areas**



Place the switch on the table, as shown in Figure 3-8.

**Figure 3-8 Mounting the Switch on the Table**



**⚠ Caution**

The device must be installed and operated in the place that can restrict its movement.

## 3.4 Grounding the Switch

The RG-NBS3100 has a PGND on the back panel. First connect the PGND to the grounding lug of the rack and then connect the grounding lug to the grounding bar of the equipment room.

**Precautions**

- Determine the sectional area of the grounding wire according to the possible maximum current, and use cables of the good conductor.
- Do not use bare wires.
- The grounding electric resistance should be less than 1  $\Omega$ .

---

**⚠ Caution**

- To guarantee the security of the body and the device, the switch must be well-grounded. The grounding resistance for combined grounding should be less than 1  $\Omega$ .
  - The maintenance personnel must check whether the AC socket powering the switch is well connected to the building protective earth (PE). If not, the personnel must connect the grounding lug of the AC socket to the PE with a grounding connector.
  - The AC socket must be installed near the device and easily used.
  - When installing the switch, ensure that the grounding is connected first and then disconnected.
  - The cross-sectional area of the PE conductor must be at least 2.5 mm<sup>2</sup> (12 AWG).
- 

## 3.5 Connecting External Cables

### Precautions

- Correctly distinguish single-mode and multimode fibers and ports.
- Avoid bends of the small radius at the connector.

### Steps

Step 1: Connect one end of the Ethernet cable to the MGMT port of the device, and the other end to the NMS or a control terminal.

Step 2: Insert the single-mode or multimode fiber into the appropriate port according to the identification on the panel of the module.

Step 3: Insert the twisted pair with the RJ45 connector into the appropriate port according to the identification on the panel of the module. Distinguish the crossover cable and straight-through cable.

## 3.6 Bundling Cables

### Precautions

- The power cables and other cables must be well bundled.
- When you bundle fibers, make sure that the fibers at the connectors have natural bends or bends of the large radius.
- Do not bundle fibers and twisted pairs too tightly because this may press hard the fibers and affect their service time and transmission performance.

### Steps

- Bind the drooping part of the fibers and twisted pairs of each board, and lead them to both sides of the chassis for convenience.
- On both sides of the chassis, fasten the fibers and twisted pairs to the cabinet cable management ring or cabling chute.
- For power cables, bundle them closely along the bottom of the chassis, in a straight line wherever possible.

## 3.7 Checking After Installation

---

 **Caution**

Before checking the installation, switch off the power supply so as to avoid any personal injury or damage to the component due to connection errors.

---

- Check that the ground line is connected.
- Check that the cables and power input cables are correctly connected.
- Check that all interface cables are laid out inside the equipment room. In the case of external cabling, check that the lightning resistance socket or network interface lightning protector is connected.
- Check that sufficient airflow is available around the device (over 10 cm).

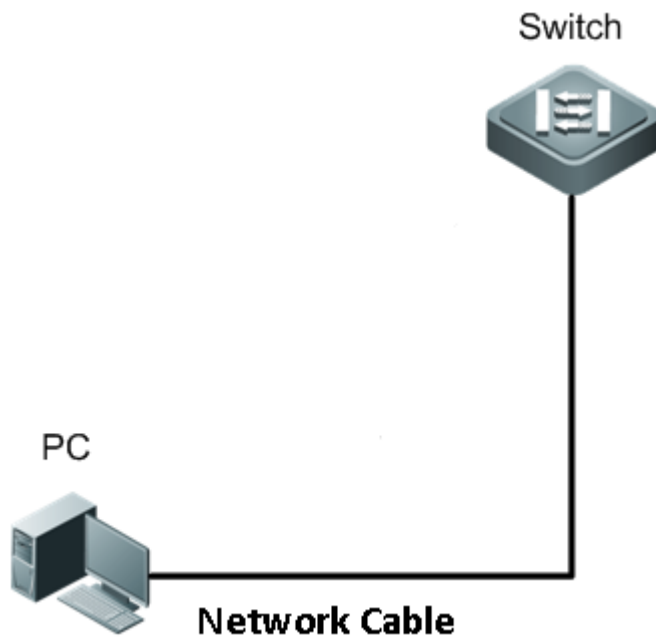
# 4 System Commissioning

## 4.1 Establishing the Configuration Environment

### Establishing the Configuration Environment

Use the network cable to connect a PC to the switch.

Figure 4-1 Configuration Environment



### Connecting the Console Cable

- Connect the one end (RJ45 port) of the network cable to the network port of the PC.
- Connect the other end (RJ45 port) of the network cable to any Ethernet port of the switch.

### Configuring the Device

Step 1: Start the PC and configure the IP address of the PC as **10.44.77.XXX**. (**10.44.77.XXX** indicates the IP address that is on the same network as the switch. XXX is in the range of 1 to 255, excluding 200. )

Step 2: Log in to the switch by accessing the IP address of 10.44.77.200 on a browser. The default password is **admin**.

## 4.2 Startup

### Checking Before Power-on

- The switch is well grounded.
- The power cable is correctly connected.
- The power cable is buckled after connected.
- The power supply voltage complies with the requirement of the switch.

- The console cable is correctly connected; the PC is already started; parameters are configured.

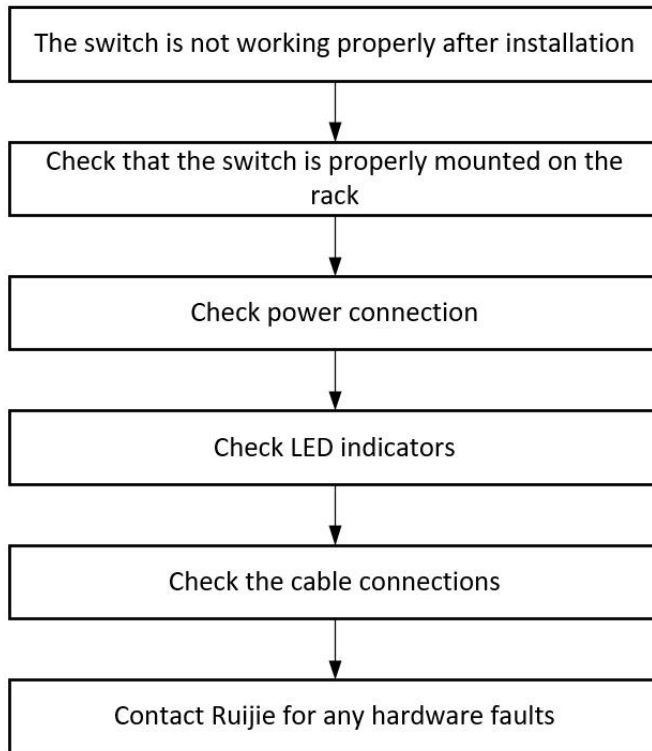
**Checking After Power-on (Recommended)**

After power-on, you are advised to perform the following checks to ensure the normal operation of follow-up configurations.

- Check whether the status of the switch indicator is normal.
- Check whether the main program is loaded normally.
- Check whether the service interface forwards data normally.

# 5 Troubleshooting

## 5.1 Troubleshooting Flowchart



## 5.2 Troubleshooting Common Faults

| Symptom  | Possible Causes  | Solution  |
|--|--|---|
| The management interface login password is forgotten.  | A password is manually configured but it is forgotten.   | Press the reset button to restore the default settings.   |
| The status LED is off after power-on.  | The power supply is not enabled, or the power cable is loosened.   | Check whether the power socket is normal.<br>Check whether the power cable is correctly connected.                          |
| The RJ45 port is not connected or an error occurs when the port is receiving or transmitting | The connected twisted pair cable is faulty.<br>The length of the cable exceeds 100 m.<br>The port has special configuration, which does not adapt to the | Replace the twisted pair cable.<br>Check that the port configuration has the common working mode with the connected switch. |

|                                       |   |   |
|---------------------------------------|---|---|
| frames.                               | working mode of the connected switch.   |   |
| The optical port cannot be connected. | <p>The Rx and Tx ends are connected reversely.</p> <p>The interconnected optical module type does not match.</p> <p>The fiber type is incorrect.</p> <p>The length of the optical module exceeds the rated value.</p> | <p>Switch the Rx and Tx ends of the optical module.</p> <p>Replace the optical module with one of the matched type.</p> <p>Replace the optical module with one of the appropriate type.</p> <p>Replace the optical module with one of the appropriate length.</p> |

# 6 Appendix A Connectors and Connection Media

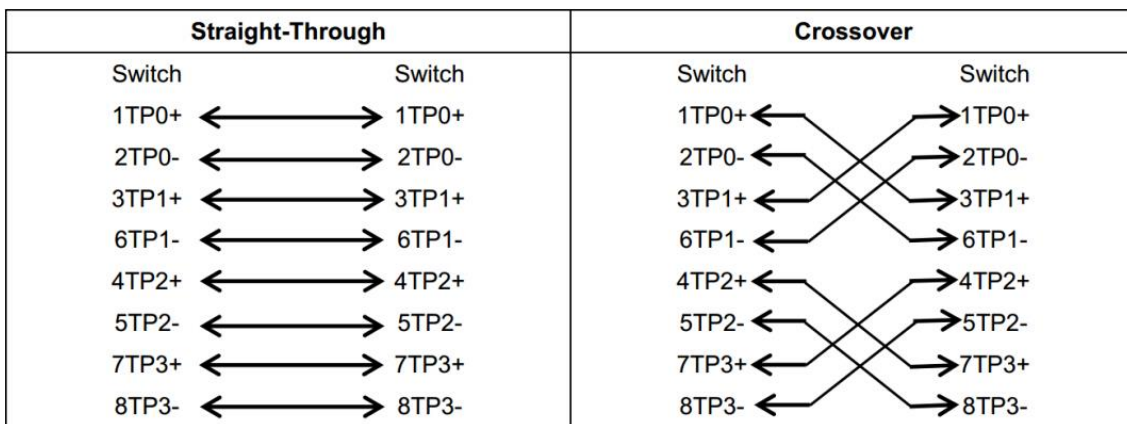
## 1000BASE-T/100BASE-TX/10BASE-T Ports

The 1000BASE-T/100BASE-TX/10BASE-T supports adaptation of three rates and automatic MDI/MDIX crossover at these three rates.

The 1000BASE-T complies with IEEE 802.3ab, and uses the cable of 100-ohm Category-5 or Super Category-5 UTP or STP, which can be up to 100 m.

The 1000BASE-T port uses four pairs of wires for transmission, all of which must be connected. Figure 6-1 shows the connections of the twisted pairs used by the 1000BASE-T port.

**Figure 6-1 Schematic Diagram for the Four Twisted Pairs of the 1000BASE-T**



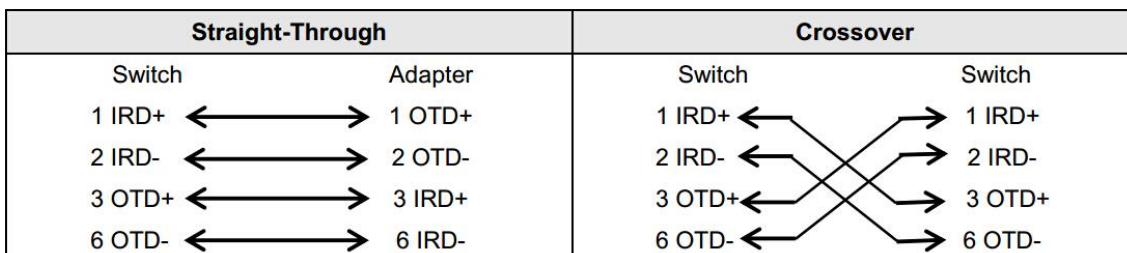
In addition to the preceding cables, the 100BASE-TX/10BASE-T can also use 100-ohm Category-3, Category-4, and Category-5 cables for 10 Mbps, and 100-ohm Category-5 cables for 100 Mbps, both of which can be up to 100 m. Figure 6-2 shows the pinouts of the 100BASE-TX/10BASE-T.

**Figure 6-2 Pinouts of the 100BASE-TX/10BASE-T**

| Pin     | Socket                | Plug                  |
|---------|-----------------------|-----------------------|
| 1       | Input Receive Data+   | Output Transmit Data+ |
| 2       | Input Receive Data-   | Output Transmit Data- |
| 3       | Output Transmit Data+ | Input Receive Data+   |
| 6       | Output Transmit Data- | Input Receive Data-   |
| 4,5,7,8 | Not used              | Not used              |

Figure 6-3 shows the straight-through and crossover cable connections for the 100BASE-TX/10BASE-T.

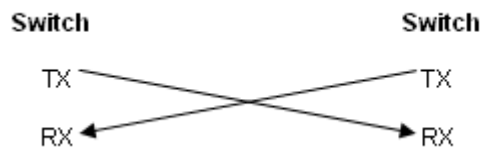
**Figure 6-3 Connections of the Twisted Pairs of the 100BASE-TX/10BASE-T**



### Optical Fiber Connection

For the optical fiber ports, select single-mode or multimode optical fibers for connection according to the fiber module connected. Figure 6-4 shows the connection schematic diagram.

**Figure 6-4 Optical Fiber Connections**



# 7 Appendix B Mini-GBIC and SPF Module

SFP modules (mini-GBIC module) and 10G SFP+ modules are available to cope with interface types of switch modules. You can select the mini-GBIC module to suit your specific needs. The models and technical specifications of some mini-GBIC and 10G SFP+ modules are listed below. For details, see *Ruijie Transceiver Installation and Reference Guide*.

**Table 7-1 Models and Technical Specifications of the 1000M Mini-GBIC Module**

| Model                    | Wave Length (nm) | Media Type | DDM (Yes/No) | Intensity of Transmitted Light (dBm) |     | Intensity of Received Light (dBm) |     |
|--------------------------|------------------|------------|--------------|--------------------------------------|-----|-----------------------------------|-----|
|                          |                  |            |              | Min                                  | Max | Min                               | Max |
| MINI-GBIC-SX-M M850      | 850              | MMF        | No           | -9.5                                 | -3  | -17                               | 0   |
| MINI-GBIC-LX-S M1310     | 1310             | SMF        | No           | -9.5                                 | -3  | -20                               | -3  |
| GE-eSFP-SX-M M850        | 850              | MMF        | Yes          | -9.5                                 | -3  | -17                               | 0   |
| GE-eSFP-LX-SM 1310       | 1310             | SMF        | Yes          | -9.5                                 | -3  | -20                               | -3  |
| GE-SFP-LX-SM1 310        | 1310             | SMF        | No           | -9.5                                 | -3  | -20                               | -3  |
| MINI-GBIC-LH40 -SM1310   | 1310             | SMF        | Yes          | -2                                   | 3   | -22                               | -3  |
| GE-SFP-SX-SM1 310-BIDI   | 1310             | MMF        | No           | -10                                  | -5  | -17                               | -3  |
| GE-SFP-SX-SM1 550-BIDI   | 1550             | MMF        | No           | -10                                  | -5  | -17                               | -3  |
| GE-SFP-LX20-S M1310-BIDI | 1310TX/1550R X   | SMF        | Yes          | -9                                   | -3  | -20                               | -3  |
| GE-SFP-LX20-S M1550-BIDI | 1550TX/1310R X   | SMF        | Yes          | -9                                   | -3  | -20                               | -3  |
| GE-SFP-LH40-S M1310-BIDI | 1310TX/1550R X   | SMF        | Yes          | -5                                   | 0   | -24                               | -1  |

|                             |                   |     |     |      |     |     |    |
|-----------------------------|-------------------|-----|-----|------|-----|-----|----|
| GE-SFP-LH40-S<br>M1550-BIDI | 1550TX/1310R<br>X | SMF | Yes | -5   | 0   | -24 | -1 |
| MINI-GBIC-ZX50<br>-SM1550   | 1550              | SMF | Yes | -5   | 0   | -22 | -3 |
| MINI-GBIC-ZX80<br>-SM1550   | 1550              | SMF | Yes | 0    | 4.7 | -22 | -3 |
| MINI-GBIC-ZX10<br>0-SM1550  | 1550              | SMF | Yes | 0    | 5   | -30 | -9 |
| GE-SFP-SX                   | 850               | MMF | No  | -9.5 | -3  | -17 | 0  |
| GE-SFP-LX                   | 1310              | SMF | No  | -9.5 | -3  | -20 | -3 |
| SFP-MM850                   | 850               | MMF | No  | -9.5 | -3  | -17 | 0  |
| SFP-SM1310                  | 1310              | SMF | No  | -9.5 | -3  | -20 | -3 |

**Table 7-2 Models and Technical Specifications of the Mini-GBIC-GT Module**

| Standard   | 1000Base-T SFP Type | DDM (Yes/No) |
|------------|---------------------|--------------|
| 1000Base-T | Mini-GBIC-GT        | No           |

**Table 7-3 Cabling Specifications of SFP Modules**

| Model                 | Optical Fiber Type | Media Type | Core Size (μm) | Maximum Cabling Distance |
|-----------------------|--------------------|------------|----------------|--------------------------|
| MINI-GBIC-SX-MM850    | LC                 | MMF        | 62.5/125       | 275 m                    |
|                       |                    |            | 50/125         | 550 m                    |
| MINI-GBIC-LX-SM1310   | LC                 | SMF        | 9/125          | 10 km                    |
| GE-eSFP-SX-MM850      | LC                 | MMF        | 62.5/125       | 275 m                    |
|                       |                    |            | 50/125         | 550 m                    |
| GE-eSFP-LX-SM1310     | LC                 | SMF        | 9/125          | 10 km                    |
| GE-SFP-LX-SM1310      | LC                 | SMF        | 9/125          | 10 km                    |
| MINI-GBIC-LH40-SM1310 | LC                 | SMF        | 9/125          | 40 km                    |
| GE-SFP-SX-SM1310-BI   | LC                 | MMF        | 50/125         | 500 m                    |

|                         |            |                               |          |        |
|-------------------------|------------|-------------------------------|----------|--------|
| DI                      |            |                               |          |        |
| GE-SFP-SX-SM1550-BIDI   | LC         | MMF                           | 50/125   | 500 m  |
| GE-SFP-LX20-SM1310-BIDI | LC         | SMF                           | 9/125    | 20 km  |
| GE-SFP-LX20-SM1550-BIDI | LC         | SMF                           | 9/125    | 20 km  |
| GE-SFP-LH40-SM1310-BIDI | LC         | SMF                           | 9/125    | 40 km  |
| GE-SFP-LH40-SM1550-BIDI | LC         | SMF                           | 9/125    | 40 km  |
| MINI-GBIC-ZX50-SM1550   | LC         | SMF                           | 9/125    | 50 km  |
| MINI-GBIC-ZX80-SM1550   | LC         | SMF                           | 9/125    | 80 km  |
| MINI-GBIC-ZX100-SM1550  | LC         | SMF                           | 9/125    | 100 km |
| GE-SFP-SX               | LC         | MMF                           | 62.5/125 | 275 m  |
|                         |            |                               | 50/125   | 550 m  |
| GE-SFP-LX               | LC         | SMF                           | 9/125    | 10 km  |
| Mini-GBIC-GT            | RJ45 cable | Category 5 (or above) UTP/STP |          | 100 m  |

**Note**

- For the optical module with the transmission distance exceeding 40 km or above, add one online optical attenuator on the link to avoid the overload of the optical receiver when short single-mode optical fibers are used.
- Optical modules generate laser. Do not look directly into the optical module.
- To keep optical modules clean, use dust caps when the modules are not connected to cables.

**Table 7-4 Specifications of SFP BIDI Optical Module Pairs**

| Rate/Distance   | Module Pairs                                       |
|-----------------|--|
| 1000 Mbps/500 m | GE-SFP-SX-SM1310-BIDI<br>GE-SFP-SX-SM1550-BIDI     |
| 1000 Mbps/20 km | GE-SFP-LX20-SM1310-BIDI<br>GE-SFP-LX20-SM1550-BIDI |
| 1000 Mbps/40 km | GE-SFP-LH40-SM1310-BIDI                            |

---

|  |                         |
|--|-------------------------|
|  | GE-SFP-LH40-SM1550-BIDI |
|--|-------------------------|

---

 **Caution**

The BIDI modules must be used in pairs, for example, FE-SFP-LX20-SM1310-BIDI and FE-SFP-LX20-SM1550-BIDI are used together.

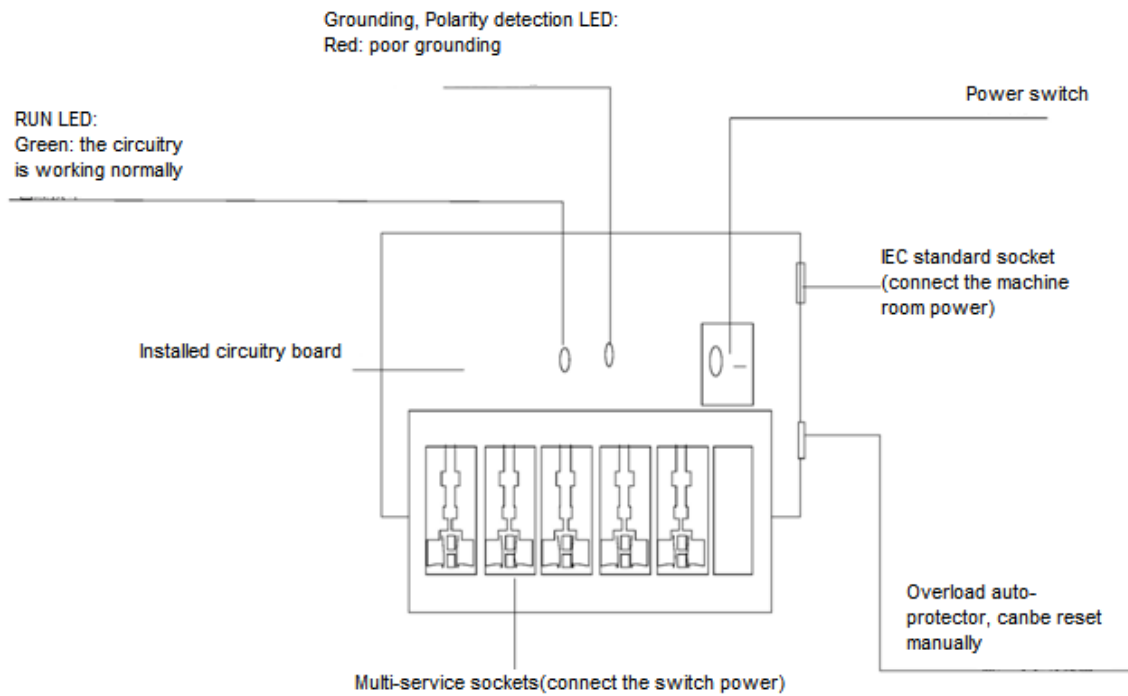
---

# 8 Appendix C Surge Protection

## Installing the AC Power Arrester (Surge Protection Cable Row)

The external surge protection cable row must be used on the AC power port to prevent the switch from being struck by lightning when the AC power cable is introduced from the outdoor and directly connected to the power port of the switch. The surge protection cable row is fixed on the cabinet, operating table, or the wall in the equipment room using the line buttons and screws.

**Table 8-1 Schematic Diagram for the Power Arrester**



**⚠ Caution**

The power arrester is not provided and customers have to purchase it.

Precautions for installation:

- Ensure that the PE terminal of the power arrester is properly grounded.
- After connecting the switch AC power plug to the socket of the power arrester (surge protection cable row), surge protection function implements if the RUN LED is Green and the ALARM LED is OFF.
- If the alarm LED on the power arrester is red, check whether there is the poor grounding connection or reversed connection of null and live lines. You can use the multimeter to check the polarity of the power socket for the arrester when the LED is red. If the N line is on the left and the L line is on the right, the arrester PE terminal is not grounded. If the L line is on the left and the N line is on the right, the polarity of the arrester power cable is reversed. If the LED is still red, the arrester PE terminal is not grounded.

### Installing the Ethernet Port Arrester

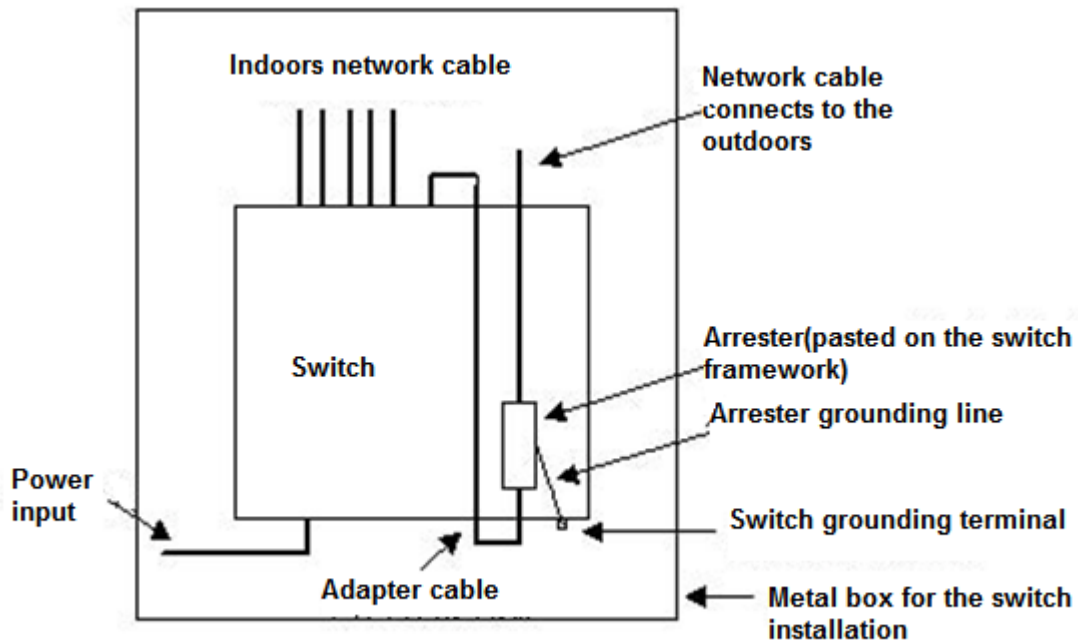
During the switch usage, the Ethernet port arrester must be connected to the switch to prevent the switch damage by lightning before the outdoor network cable connects to the switch.

Tools: cross or straight screwdriver, multimeter, and diagonal pliers

Installation steps:

- (1) Tear one side of the protection paper for the double-sided adhesive tape and paste the tape to the framework of the Ethernet port arrester. Tear the other side of the protection paper for the double-sided adhesive tape and paste the Ethernet port arrester to the switch framework. The paste location for the Ethernet port arrester must be as close to the grounding terminal of the switch.
- (2) Based on the distance of the switch grounding terminal, cut the grounding line for the Ethernet port arrester and firmly tighten the grounding line to the grounding terminal of the switch.
- (3) Use the multimeter to check whether the grounding line for the arrester is in good contact with the switch grounding terminal and the framework.
- (4) According to the *Ethernet Port Arrester Hardware Installation Guide*, connect the arrester using the adapter cable (note that the external network cable is connected to the end of IN, while the adapter cable connected to the switch is connected to the end of OUT) and check whether the LED on the board is normal.
- (5) Use the nylon button to bundle the power cables.

**Table 8-2 Schematic Diagram for the Ethernet Port Arrester Installation**



**⚠ Caution**

- The Ethernet port arrester applies to only the 10M/100M electrical Ethernet ports with the RJ45 connector.
- The Ethernet port arrester is provided by customers. For more information about arrester installation, refer to *Ethernet Port Arrester Hardware Installation Guide*.

To prevent the performance of the Ethernet port arrester from being affected, note the following points:

- Reversed direction of the arrester installation: Connect the external network cable to the IN end and connect the switch Ethernet port to the OUT end.
- Poor arrester grounding: The grounding line must be as short as possible to ensure that it is in good contact with the switch grounding terminal. Use the multimeter to confirm the contact after grounding.
- Incomplete arrester installation: If more than one port is connected to the peer device on the switch, install

the arresters on all connection ports for surge protection.

# 9 Appendix D Cabling Recommendations

When RG-NBS3100 series switches are installed in standard 19-inch cabinets, cables are tied in the binding rack on the cabinet by the cabling rack, and top or bottom cabling is adopted according to the actual situation in the equipment room. All cable connectors should be placed at the bottom of the cabinet in an orderly manner but not outside the cabinet. Power cables are routed beside the cabinet, and top or bottom cabling is adopted according to the actual situation in the equipment room, such as the position of the DC power distribution box, AC socket, or surge protection box.

## Requirement for the Minimum Cable Bending Radius

- The bending radius of a power cord, communication cable, and flat cable should be five times greater than their respective diameters. The bending radius of these cables that often bend or is removed or installed should be seven times greater than their respective diameters.
- The bending radius of a common coaxial cable should be seven times greater than its diameter. The bending radius of this type of cables that often bend or is removed or installed should be 10 times greater than its diameter.
- The bending radius of a high-speed cable (for example, SFP cable) should be five times greater than its diameter. The bending radius of this type of cables that often bend or is removed or installed should be 10 times greater than its diameter.

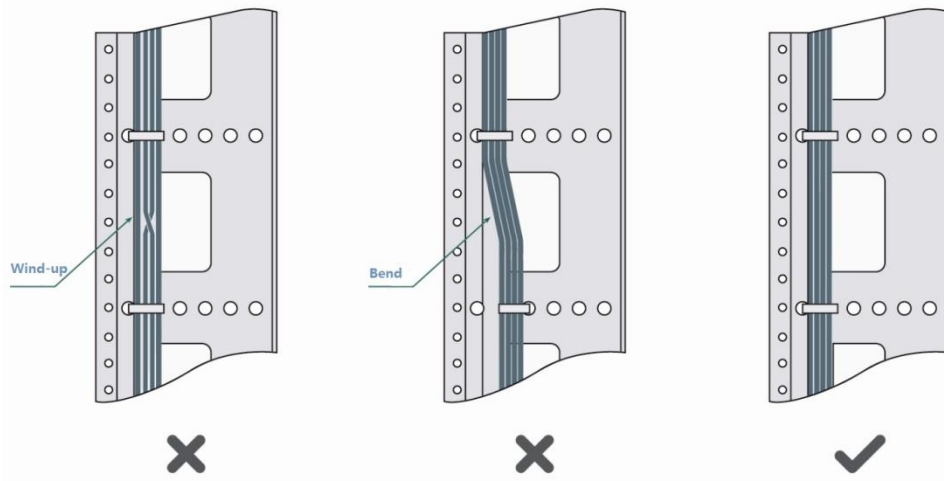
## Requirement for the Minimum Fiber Bending Radius

- The diameter of a fiber tray to hold fibers cannot be 25 times less than the diameter of the fiber.
- When moving an optical fiber, the bending radius of the fiber should be equal to or 20 times greater than the diameter of the fiber.
- During cabling of an optical fiber, the bending radius of the fiber should be equal to or 10 times greater than the diameter of the fiber.

## Precautions for Bundling Up Cables

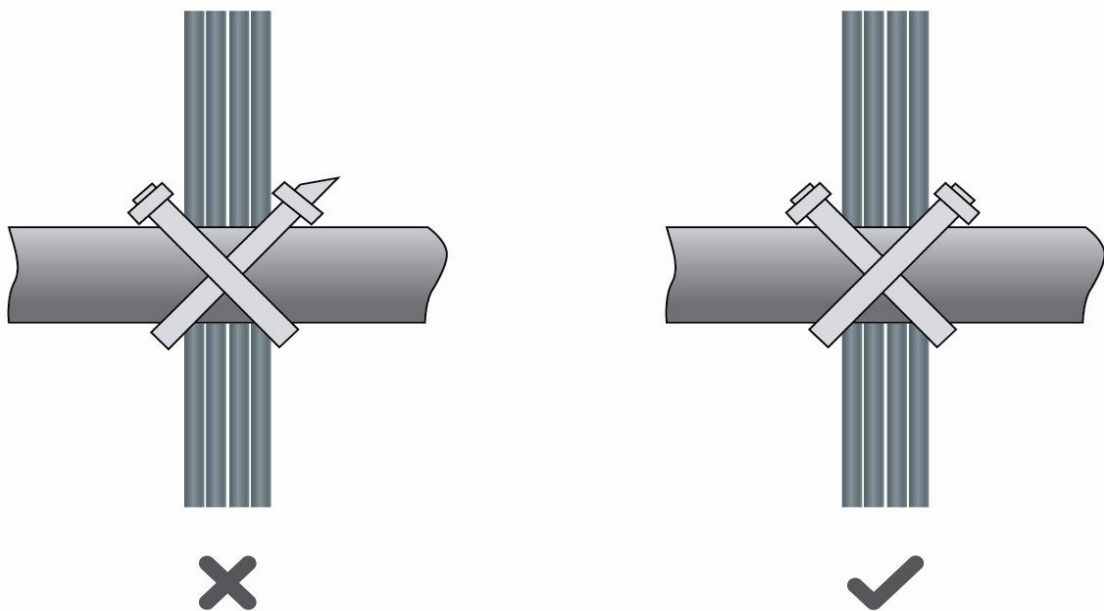
- Before bundling up cables, correctly mark labels and stick the labels to cables.
- Cables should be neatly and properly bundled, as shown in Figure 9-1.

**Figure 9-1 Bundling Up Cables**



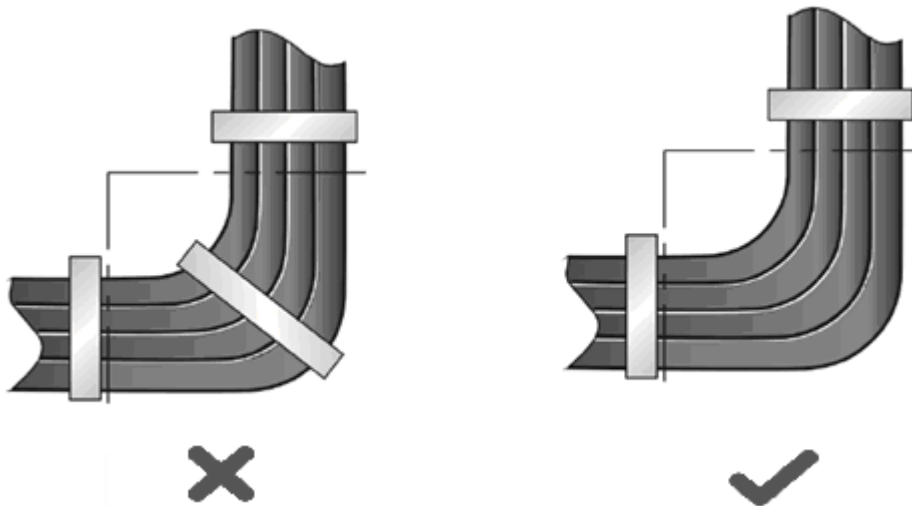
- Route and bundle power, signal, ground cables separately. When the cables are close to each other, cross them. When power cables are parallel to signal cables, the distance between them must be 30 mm (1.18 in.).
- All cable trays and their accessories must be smooth and free from sharp edges.
- Holes in metal, through which cables pass must have smooth or well-rounded surfaces, and be protected with insulating bushings.
- Use proper cable ties to bind cables together. Do not tie two or more cable ties to bind cables.
- Cut off excess cable tie cleanly with no sharp edges after bundling cables, as shown in Figure 9-2.

**Figure 9-2 Cutting Off Excess Cable Tie**



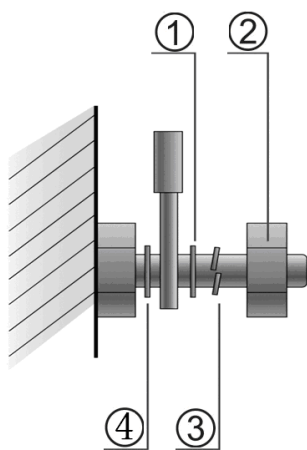
- If cables are to be bent, bind them first but do not tie cable ties within the bend to avoid stress on the cables, which may cause the wires inside to break, as shown in Figure 9-3.

**Figure 9-3 Preventing Cable Ties from Being Tied within the Bend**



- Wrap up unnecessary or excess cables and bind them to the appropriate rack position, where device operation is not affected and no damages occur to the device and cables during commissioning.
- Do not bind power cords to the rails for moving parts.
- Leave a specified length of the cable connecting moving parts, such as the ground wire of the cabinet door, to avoid stress on the cable. When moving parts are in place, ensure that the excess cable length does not contact heat sources, sharp corners, or edges. If heat sources are unavoidable, use high-temperature cables instead.
- When using screws to fasten cable lugs, the bolts or nuts should be tightened and prevented from loosening, as shown in Figure 9-4.

**Figure 9-4 Fastening Cable Lugs**



|      |                    |                              |
|------|--------------------|------------------------------|
| Note | Flat washer<br>Nut | Spring washer<br>Flat washer |
|------|--------------------|------------------------------|

- When using a stiff cable, fix it near the cable lug to avoid stress on the lug and cable.
- Do not use self-tapping screws to fasten terminals.

- Bundle cables of the same type and running in the same direction into groups. Keep cables clean and straight.
- Cables should be tied according to the following table.

| Diameter of Cable Bundle (mm) | Space Between Bundles (mm) |
|-------------------------------|----------------------------|
| 10                            | 80 to 150                  |
| 10 to 30                      | 150 to 200                 |
| 30                            | 200 to 300                 |

- No knot is allowed in cabling or bundling.
- The metal parts of the cold-pressed terminal blocks, such as air circuit breakers, should not be exposed outside of the blocks.

# 10 Appendix E Site Selection

- The equipment room should be at least 5 km away from the heavy pollution source such as the smelter, coal mine, and thermal power plant, 3.7 km away from the medium pollution source such as the chemical industry, rubber industry, and electroplating industry, and 2 km away from the light pollution source such as the food manufacturer and leather plant. If the pollution source is unavoidable, the equipment room should be located on the windward side of the pollution source perennially with advanced protection.
- The equipment room should be at least 3.7 km away from the sea or salt lake. Otherwise, the equipment room must be sealed, with air conditioner installed for temperature control. Saline soil cannot be used for construction. Otherwise, you should select devices with advanced protection against severe environment.
- Do not build the equipment room in the proximity of livestock farms. Otherwise, the equipment room should be located on the windward side of the pollution source perennially. The previous livestock house or fertilizer warehouse cannot be used as the equipment room.
- The equipment room should be firm enough to withstand severe weather conditions such as windstorm and heavy rain as well as away from dust. If the dust is unavoidable, keep the door and window away from the pollution source.
- The equipment room should be away from the residential area. Otherwise, the equipment room should meet the construction standard in terms of noise.
- Make sure that the air vent of the equipment room is away from the sewage pipe, septic tank, and sewage treatment tank. Keep the equipment room under positive pressure to prevent corrosive gas from entering the equipment room to corrode components and circuit boards. Keep the equipment room away from industrial boiler and heating boiler.
- The equipment room had better be on the second floor or above. Otherwise, the equipment room floor should be 600 mm higher than the highest flood level ever recorded.
- Make sure that there are no cracks or holes in the wall and floor. If there are cable entries in the wall or window, take proper sealing measures. Ensure that the wall is flat, wear-resistant, and dust-free, which must meet requirements of flame retarding, soundproofing, heat absorption, dust reduction, and electromagnetic shielding.
- Keep the door and the window closed to make the equipment room sealed.
- The steel door is recommended for soundproofing.
- Sulfur-containing materials are forbidden.
- Pay attention to the location of the air conditioner. Keep the air conditioner from blowing wind straight toward the device or blowing water drops from the window or air vent toward the device.